



商 用 電 熱 產 品 及 食 品 處 理 器

ELECTRIC HEATED
FOOD PROCESSING
C A T A L O G U E

商用電熱設備, 炸爐、電蒸爐、烘焙焗爐、汁箱、蒸櫃、食物處理器 etc

電熱產品目錄 Contents

茶水罈 / 濾水器設備	2	<i>WATER BOILER / WATER FILTERS EQUIPMENT</i>
蒸櫃 / 中式焗爐	8	<i>CHINESE COOKER</i>
飯煲系列	11	<i>RICE COOKER SERIES</i>
焗爐 / 烘培系列	16	<i>OVEN / BAKING SERIES</i>
食品處理器械	25	<i>FOOD PROCESSING MACHINERY</i>
小食設備	44	<i>STREET FOOD EQUIPMENT</i>
燒烤設備	50	<i>SKEWER FURNACE / BBQ EQUIPMENT</i>
保溫設備	52	<i>FOOD WARMING EQUIPMENT</i>
不銹鋼煮食用具	55	<i>STAINLESS STEEL COOKING EQUIPMENT</i>
中式煤氣爐具	59	<i>CHINESE GAS COOKER</i>
洗碗碟機系列	61	<i>DISHWASHER SERIES</i>
商用風扇	63	<i>FANS</i>
清潔消毒用品	64	<i>DISINFECT EQUIPMENT</i>
ROLLER GRILL 餐飲設備	66	<i>ROLLER GRILL CATERING EQUIPMENT</i>
設備安裝實例	72	<i>EQUIPMENT INSTALLATION REFERENCES</i>

茶水罇 / 濾水器設備 Water Boiler / Water Filters Equipment
2 ~ 7



蒸櫃 / 中式焗爐 Stainless Steel Chinese Steam Cabinet / Steamer / Chinese Oven
8 ~ 10



商用電飯煲及暖飯煲系列 Commerical Rice Cooker & Warmer
11



環寶牌商用電磁爐 Gem - Commercial Induction Cooker
12~13



電磁爐 / 電陶爐 Induction Cooker / Electronic Ceramic Cooker
14~15



焗爐 / 微波爐 Oven / Microwave Oven
16 ~ 22



慢煮棒 / 抽真空機 Sous-vide Cooking / Vacuum Pack Machine
23~24



食品處理器械 Food Processing Machinery
25 ~ 37



日本食品處理器 Japanese Food Processing Machine
30 ~ 31



台灣食品機械 Taiwan Food Machinery
38 ~ 41



食品機械 Food Machinery
42



凍飲機 Frozen Drink Machine
43



小食設備 Street Food Equipment
44 ~ 47



面火爐 / 多士爐 Electric Salamander / Toaster
48 ~ 49



串燒爐 / 電熱汁箱 Skewer Furnace / Bain Marie
50 ~ 51



燒臘電烤爐 Siu Mei (Roasted Meat) Oven
52



保溫設備 Food Warmer / Food Warmer Cart
53 ~ 54



餐飲保溫設備 Catering Equipment - Warmer
55



不銹鋼煮食用具 Stainless Steel Cooking Equipments
56 ~ 59



不銹鋼外賣車 Stainless Steel Take-away Cart
57 ~ 58



中式煤氣爐具 Chinese gas cooker
60 ~ 61



洗碗碟機系列 Dishwasher series
62 ~ 63



商用風扇 Fans
64



消毒碗櫃 Dish Sterilizer
65



毛巾櫃 / 滅蚊燈 Towel Cabinet / Insect killers
66



Roller Grill 餐飲設備 Roller Grill Catering Equipment
67 ~ 72





■ 採用 304 不銹鋼
304 stainless steel

不銹鋼全自動電熱水罈 Squared Water Boiler

型號 Model	水龍頭數量 Faucet Quantity	容量 Capacity	尺寸 (只含機身) – 闊 × 深 × 高 Dimensions (Body only) – W × D × H		功率 Power (w)	電壓 Voltage (V)
		加侖 (gal)	(mm)	(in)		
H001-G06	1	6	343×216×546	13.5"×8.5"×21.5"	2,000	220
H001-G08	1	8	355×228×610	14"×9"×24"	2,500	220
H001-G10	1	10	406×254×711	16"×10"×28"	3,000	220
H001-G15	1	15	432×279×800	17"×11"×31.5"	6,000	380
H001-G20	2	20	457×305×927	18"×12"×36.5"	6,000	380
H001-G25	2	25	470×356×1029	18.5"×14"×40.5"	9,000	380
H001-G30	2	30	597×381×1130	23.5"×15"×44.5"	18,000	380
H001-G40	2	40	610×406×1168	24"×16"×46"	18,000	380



電熱水罈連下座

茶水罈設備 WATER BOILER EQUIPMENT



型號 Model	水龍頭數量 Faucet Quantity	容量 Capacity	尺寸 (只含機身) – 闊 × 深 × 高 Dimensions (Body only) – W × D × H		功率 Power (w)	電壓 Voltage (V)	
		公升 (L)	(mm)	(in)			
白色 White	ZK-401S	1	40	414×214×645	16.5"×8.5"×25.5"	3,000	220
	ZK-702S	2	70	414×214×745	16.5"×8.5"×29.5"	6,000	220
不銹鋼 Stainless Steel	ZK-401W	1	40	414×214×645	16.5"×8.5"×25.5"	3,000	220
	ZK702W	2	70	414×214×745	16.5"×8.5"×29.5"	6,000	220

電熱雙管 / 三管啡罈 Squared Water Boiler with taps



三管啡罈

雙管啡罈

型號 Model	容量 Capacity	尺寸 – 闊 × 深 × 高 Dimensions – W × D × H		功率 Power (w)	電壓 Voltage (V)
	加侖 (gal)	(mm)	(in)		
H002-COF11.6 雙管	6	385×310×490	15"×12"×19"	3,000	220
H002-COF11 自動雙管	8	480×280×660	19"×11"×26"	6,000	220
H002-COF12.6 三管	6	380×310×490	15"×12"×19"	3,000	220
H002-COF12 自動三管	8	480×340×660	19"×13.5"×26"	6,000	220
ZK-9E	20	450×400×895	18"×16"×35.5"	9,000	380
ZK-18E	40	556×455×1195	22"×18"×47"	18,000	380

產品不斷改良，如有更改，均以實物為準。
Products are subject to change due to enhancements and continuous development.

可加水龍頭擋板 避免熱水濺出

* 全部水罈都可加購水龍頭擋板。



新款不銹鋼水龍頭
防滴水更耐用

電熱圓水罈 Rounded Water Boiler with tap

型號 Model	容量 Capacity	尺寸 (只含機身) - 闊 × 深 × 高 Dimensions (Body only) - W × D × H		功率 Power	電壓 Voltage
	公升 (L)	(mm)	(in)		
WF341	8	310 × 295 × 400	12" × 11.6" × 16"	1600	220
WF342	10	310 × 295 × 450	12" × 11.6" × 18"	1600	220
WF343	16	370 × 290 × 445	14.5" × 11" × 17.5"	2200	220
WF344	20	370 × 290 × 515	14.5" × 11" × 20"	2200	220
WF345	30	440 × 410 × 480	17" × 16" × 19"	2500	220
WF346	40	440 × 410 × 595	17" × 16" × 23"	2500	220

電熱圓水罈 (水尺) Rounded Water Boiler with indicator

型號 Model	容量 Capacity	尺寸 (只含機身) - 闊 × 深 × 高 Dimensions (Body only) - W × D × H		功率 Power	電壓 Voltage
	公升 (L)	(mm)	(in)		
RBI0015	1.5	∅ 185 × 320	∅ 7.5" × 12.5"	1,000	220
RBI0025	2.5	∅ 240 × 335	∅ 9.5" × 13.5"	2,000	220
RBI0040	4	∅ 295 × 450	∅ 11.5" × 18"	3,000	220
RBI0060	6	∅ 295 × 480	∅ 11.5" × 19"	3,000	220
RBI0080	8	∅ 350 × 466	∅ 14" × 18.5"	3,000	220
RBI0100	10	∅ 350 × 542	∅ 14" × 21"	3,000	220



ZK-2Y



ZK-3Y



ZK-9Y

- 可快速加熱水，提供您所需的溫度
- 採用優質材料製成，堅固耐用



電熱電水罈 Water Boiler

型號 Model	容量 Capacity	尺寸 (只含機身) - 闊 × 深 × 高 Dimensions (Body only) - W × D × H		功率 Power	電壓 Voltage
	公升 (L)	(mm)	(in)		
ZK-2Y	6	200 × 425 × 540	8" × 16.5" × 21.5"	2,000	220
ZK-3Y	7	190 × 380 × 520	7.5" × 15" × 20.5"	2,000	220
ZK-9Y	9	200 × 425 × 670	8" × 16.5" × 26.5"	2,500	220

INSTANT-MATE



WM-12



WM-30



WM-35-1



WM-60-1 / WM-80-1



WM-60F / WM-80F



WM-100-1/WM-180-1/WM-200-1

捷寶牌 - 新版高速電開水器 Instant Mate - Instantaneous Water Boiler

型號 Model	產品 Product	出水量 Water Output	尺寸 - 濶 × 深 × 高 Dimensions - W × D × H	功率 Power	電壓 Voltage
		公升 (L)	(mm)	(w)	(V)
WM-12	座枱高速電開水器 Counter Top Instantaneous Water Boiler	15	212×312×430	1,000	220
WM-30		20	300×282×470	1,500	220
WM-35-1		30	220×438×490	2,000	220
WM-60-1		55	345×355×675	2,850	220
WM-80-1		90	345×355×675	6,000	380
WM-60F-1	窄身版高速電開水器 Slim Version Instantaneous Water Boiler	45	220×480×675	2,850	220
WM-80F-1		80	220×480×675	6,000	380
WM-100-1	大容量高速電開水器 Bulk Volume Version Instantaneous Water Boiler	180	510×440×950	9,000	380
WM-180-1		200	510×440×950	15,000	380
WM-200-1		240	510×440×950	18,000	380

複刻版

I-AquaClassic



IWB-35



IWB-60 / IWB-80



IWB-60F / IWB-80F



IWB-100

捷寶牌 - 複刻版高速電開水器 Instant Mate - Instantaneous Water Boiler (I AQUA CLASSIC)

型號 Model	產品 Product	出水量 Water Output	尺寸 - 濶 × 深 × 高 Dimensions - W × D × H	功率 Power	電壓 Voltage
		公升 (L)	(mm)	(w)	(V)
IWB-35	座枱高速電開水器 Counter Top Instantaneous Water Boiler	30	212×366×471	2,000	220
IWB-60		55	340×350×650	2,850	220
IWB-80		90	340×350×650	6,000	380
IWB-60F	窄身版高速電開水器 Slim Version Instantaneous Water Boiler	45	220×485×650	2,850	220
IWB-80F		80	220×485×650	6,000	380
IWB-100	大容量高速電開水器 Bulk Volume Version Instantaneous Water Boiler	180	510×435×930	9,000	380

Polaris 枱面式飲水機 Polaris - Counter Top POU Cooler

POU1ACTHSKY	
尺寸 - 闊 × 深 × 高 Dimensions - W × D × H (mm)	335 × 350 × 430
最大耗電量 Maximum power consumption (w)	230
最大耗電量 (熱水選項) Maximum power consumption (Hot version) (w)	1080
溫度 Temperature (°C)	冷 Chilled 5-12°C ; 熱 Hot 85°C
公升 / 每小時 Litres per hour (L)	冷 Chilled 5L ; 熱 Hot 5.4L
淨重 Approx. Net Weight (kg)	13.6
出水選項 Water options	常溫、冷熱 Ambient, Chilled & Hot
冷卻技術 Cooling Technology	對流冷卻冷凝器 Convection Cooled Condenser



POU1ACTHSKY

Polaris 座地飲水機 Polaris - Bottom Load Water Cooler

BAEB1SHSKY	
尺寸 - 闊 × 深 × 高 Dimensions - W × D × H (mm)	330 × 370 × 1105
淨重 Approx. Net Weight (kg)	15
功率 Input Power (V)	230V, 50 Hz
出水選項 Water options	常溫、冷熱 Ambient, Chilled & Hot
制冷劑 Refrigerant	R-134a
排水 Drainage Type	可拆卸滴水盤 Removable Drip-Tray



BAEB1SHSKY

■ 飲水機可以轉換過濾器
Easy to convert to a bottleless water cooler

PURIODIC

濾芯獲得 NSF 認證



UD-200



PCT-110

美國 PURIODIC 飲水機 PURIODIC - Commercial Water Cooler

型號 Model	尺寸 - 闊 × 深 × 高 Dimensions - W × D × H	製冷 / 製熱功能	熱 / 冷水箱容量	進口水壓	進口管尺寸	電壓 Voltage
	(mm)	(L/hr)	(L)	(psi)	(in/mm)	(V)
UD-200	230 × 435 × 395	製冷 up to 20	熱水箱 2.2	16 to 80	1/4 inch (6.35mm)	AC 110V / 220V
		製熱 up to 12	冷水箱 3.5			
PCT-110	330 × 420 × 420	製冷 up to 20	熱水箱 1.6	16 to 80	1/4 inch (6.35mm)	AC 110V / 220V
		製熱 up to 12	冷水箱 2.2			
PFS-110	330 × 420 × 1320	製冷 up to 20	熱水箱 1.6	16 to 80	1/4 inch (6.35mm)	AC 110V / 220V
		製熱 up to 12	冷水箱 2.2			



PFS-110

PURIODIC

美國 PURIODIC 商用濾水器
PURIODIC Commercial Water Filters

美國國家衛生基金會 NSF/ANSI 401

全球首個去除水中微膠粒認證

The world's first NSF/ANSI 401 Certified for Microplastics reduction



商業用途 / 教育機構 / 辦公室 / 餐飲業 / 醫療服務 / 餐飲業 / 公眾場所 / 老人院



CS-17HF	
有效濾水量 Capacity	21,000 gallons (79,494L)
每分鐘流量 Water flow/min	6.4 L
溫度 Temperature	2~38°C
水壓 Water Pressure	10~125 psi
尺寸 - 闊 × 深 × 高 Dimensions - W × D × H (mm)	100 × 100 × 480



CS-17HF with PF	
有效濾水量 Capacity	21,000 gallons (79,494L)
每分鐘流量 Water flow/min	6.4 L
溫度 Temperature	2~38°C
水壓 Water Pressure	10~125 psi
尺寸 - 闊 × 深 × 高 Dimensions - W × D × H (mm)	270 × 140 × 480



TWIN CS-17HF	
有效濾水量 Capacity	42,000 gallons (158,928L)
每分鐘流量 Water flow/min	12.8 L
溫度 Temperature	2~38°C
水壓 Water Pressure	10~125 psi
尺寸 - 闊 × 深 × 高 Dimensions - W × D × H (mm)	270 × 130 × 475



PF-10	
有效濾水量 Capacity	7,925 gallons (30,000L)
每分鐘流量 Water flow/min	5.68 L
溫度 Temperature	2~38°C
水壓 Water Pressure	10~125 psi
尺寸 - 闊 × 深 × 高 Dimensions - W × D × H (mm)	80 × 80 × 270

有效過濾 Reduces

- ◆ 囊蟲 Cyst
- ◆ 微塑料 Microplastic
- ◆ 防止水垢和阻塞 Scale and clogging prevention
- ◆ 重金屬 Heavy Metal

- ◆ 氯味和異味 Chlorine taste & odor
- ◆ 污垢和濁度 Dirt and cloudiness
- ◆ 通過機械手段減少大小為 0.5 微米的微粒

Reduces particles as small as 0.5 micron in size by mechanical means

紫外線殺菌器 (供水系統) – 為直接飲用或噴泉及組合應用提供優質水源



PUV-01	
消毒波段 Disinfection Waveband	UVC 260-280NM
每分鐘流量 Water flow/min	2.0- 3.0
溫度 Temperature	5-45°C
水壓 Water Pressure	0.1-0.4Mpa
尺寸 - 闊 × 深 × 高 Dimensions - W × D × H (mm)	145 × 55 × 225
功率 Power	5/10W

應用 Application

- ✓ 直接飲用水龍頭 Drinking water directly from the tap
- ✓ 飲水機 Water dispenser
- ✓ 其他混合系統 Different hybrid systems
- ✓ 智能廁所板 Smart toilet board

商用濾水器
COMMERCIAL WATER FILTERS

PENTAIR
EVERPURE
美國 PENTAIR 商用濾水器
PENTAIR Commercial Water Filters

榮獲 NSF 國際認證

- ★ NSF/ANSI 認證 42 – 口感品質測試
- ★ NSF/ANSI 認證 53 – 衛生日品質測試

System Tested and Certified by NSF International against NSF/ANSI Standard 42 and 53 for the reduction of the claims specified on the Performance Data Sheet.



100% 美國原裝進口，品質保證。



4C	
處理水量 Capacity	11,350 L
每分鐘流量 Water flow/min	1.9 L
溫度 Temperature	2°C ~ 38°C (不適用於熱水 not for hot water)
水壓 Water Pressure	10-125 psi 0.7-8.6 bar (non-shock)
尺寸 – 直徑 × 高 Dimensions – Dia. × H	∅ 3.25" × 14.5" ∅ 83 × 368 mm

有效過濾 Reduces

- ☹ 餘氯 Chlorine ☹ 污垢 Dirt
- ☹ 異色異味 Off Tastes & Odors
- ☹ 微粒 Small particles ☹ 石棉纖維 Asbestos fiber



MC2	
處理水量 Capacity	34,000 L
每分鐘流量 Water flow/min	6.3 L
溫度 Temperature	2°C ~ 38°C (不適用於熱水 not for hot water)
水壓 Water Pressure	10-125 psi 0.7-8.6 bar (non-shock)
尺寸 – 直徑 × 高 Dimensions – Dia. × H	∅ 3.25" × 20.75" ∅ 83 × 527 mm

有效過濾 Reduces

- ☹ 霉菌 Molds ☹ 餘氯 Chlorine
- ☹ 污垢 Dirt ☹ 異色異味 Off Tastes & Odors
- ☹ 微粒 Small particles ☹ 石棉纖維 Asbestos fiber



7FC-L		
處理水量 Capacity	除鉛容量 Reduces Lead	28,012 L
	去除異色異味 Off Tastes & Odors	56,000 L
每分鐘流量 Water flow/min		10.2 L
溫度 Temperature		2°C ~ 38°C (不適用於熱水 not for hot water)
水壓 Water Pressure		10-125 psi 0.7-8.6 bar (non-shock)
尺寸 – 直徑 × 高 Dimensions – Dia. × H		∅ 3.25" × 20.75" ∅ 83 × 527 mm

有效過濾 Reduces

- ☹ 鉛 Lead ☹ 霉菌 Molds ☹ 餘氯 Chlorine
- ☹ 污垢 Dirt ☹ 異色異味 Off Tastes & Odors
- ☹ 微粒 Small particles



i2000 ²	
處理水量 Capacity	34,000 L
每分鐘流量 Water flow/min	6.3 L
溫度 Temperature	2°C ~ 38°C (不適用於熱水 not for hot water)
水壓 Water Pressure	10-125 psi 0.7-8.6 bar (non-shock)
尺寸 – 直徑 × 高 Dimensions – Dia. × H	∅ 3.25" × 20.75" ∅ 83 × 527 mm

有效過濾 Reduces

- ☹ 餘氯 Chlorine ☹ 污垢 Dirt
- ☹ 異色異味 Off Tastes & Odors ☹ 微粒 Small particles
- ☹ 石灰凝結成的水垢 Damaging Limescale

Meisui



日本 Meisui 商用濾水器 Meisui Commercial Water Filters

- 椰子殼顆粒狀活性炭 + 纖維狀活性炭類型
Granular coconut shell activated carbon + Fibrous activated carbon model
- 精簡型，連狹窄空間也可安裝。
The slim model can be installed in even tight places.

有效過濾 Reduces

- ☹ 餘氯 Chlorine ☹ 污垢 Dirt ☹ 霉菌 Molds ☹ 微粒 Small particles
- ☹ 異色異味 Off Tastes & Odors ☹ 三鹵甲烷 Trihalomethanes

型號 Model	尺寸 – 直徑 × 高 Dimensions – ∅ × H	處理水量 Capacity (L)	每分鐘流量 Water flow/min (L)	最高使用溫度 Temperature	水壓 Water Pressure
F-1	∅ 3.07" × 10.71" ∅ 78 × 272 mm	50,000	5	35°C (不適用於熱水 not for hot water)	0.10 ~ 0.75 MPa (1.0 ~ 7.6 kgf/cm ²)



- * 淨水能力，是根據 JIS S 3201 家庭用淨水器測試方法的測試結果。
Filtration power is a test result calculated using JIS S 3201 - household water purifier testing methods.
- * 無法將硬水轉成軟水
Hard water cannot be changed into soft water.

- * 請只用游離剩餘氯 0.1mg/L 以上的自來水。
Please use only for tap water which contains 0.1 mg/L or more of free residual chlorine.



不銹鋼中式蒸櫃 Stainless Steel Chinese Steam Cabinet

型號 Model	MB2430 雙門紅柄蒸櫃	MB2422 四掩門蒸櫃	MB2428 座枱上下掩門紅柄蒸櫃	
尺寸 - 闊 × 深 × 高 Dimensions - W × D × H	(mm)	610 × 560 × 1700	585 × 535 × 1575	510 × 460 × 1005
	(in)	24" × 22" × 67"	23" × 21" × 62"	20" × 18" × 39.5"
功率 Power	(w)	4 × 3,000	4 × 3,000	2 × 2,000
電壓 Voltage	(V)	220	220	220

- 缺水保護功能
Low water level indicator and power cut off



壓力座枱蒸櫃 — 玻璃門 Stainless Steel Chinese Steam Cabinet — glass door

型號 Model	FB-STP-1D	
尺寸 - 闊 × 深 × 高 Dimensions - W × D × H	(mm)	580 × 650 × 700 (外寸 Outer) 330 × 550 × 506 (內寸 Inner)
	(in)	23" × 25.5" × 27.5" (外寸 Outer) 13" × 22" × 20" (內寸 Inner)
功率 Power	(w)	9,000 6,000
電壓 Voltage	(V)	380V, 50Hz 220V, 50Hz



電熱點心蒸籠櫃 Stainless Steel Dim Sum Steam Cabinet

型號 Model	MB2730	
尺寸 - 闊 × 深 × 高 Dimensions - W × D × H	(mm)	685 × 750 × 765
	(in)	27" × 29.5" × 30"
功率 Power	(w)	6,000 × 3
電壓 Voltage	(V)	380



可訂造單門或雙門

Single door or 2 doors can be tailor-Made

- 缺水保護功能
- 包括 3 個層網
- 紅色掣為電量保險掣，全掣開啟電量可達 27kW

電熱三門壓力蒸櫃 Stainless Steel Chinese Steam Cabinet — 3 doors

型號 Model	MB2427	MB3133	
尺寸 - 闊 × 深 × 高 Dimensions - W × D × H	(mm)	700 × 750 × 1850	800 × 850 × 1850
	(in)	27.5" × 29.5" × 73"	31" × 33" × 73"
功率 Power	(w)	9,000 × 3	9,000 × 3
電壓 Voltage	(V)	380	380



座枱蒸櫃
Desktop Steamer



型號 Model		LP36 電熱蒸櫃座	MME-500H 四面玻璃電蒸包櫃	MME-600H 四面玻璃電蒸包櫃
尺寸 - 闊 × 深 × 高 Dimensions - W × D × H	(mm)	400 × 400 × 500	380 × 400 × 745	457 × 567 × 824
	(in)	16" × 16" × 20"	15" × 16" × 29"	18" × 22" × 32.5"
功率 Power	(w)	3,000	900	1,200
電壓 Voltage	(V)	220	220	220

座枱蒸櫃
Desktop Steamer



型號 Model		SW-018 玻璃掩門展示蒸櫃	SW-018A 單掩門蒸櫃	SW-020 玻璃雙掩門蒸櫃 (另有玻璃趟門)
尺寸 - 闊 × 深 × 高 Dimensions - W × D × H	(mm)	500 × 450 × 935	500 × 450 × 935	500 × 450 × 935
	(in)	20" × 18" × 37"	20" × 18" × 37"	20" × 18" × 37"
功率 Power	(w)	2 × 2,000	2 × 2,000	2,000 × 2
電壓 Voltage	(V)	220	220	220

櫃桶式不銹鋼蒸櫃
Stainless Steel Chinese Steam Cabinet



型號 Model		MB2415.5 雙掩門蒸櫃	MB2415.3 三掩門蒸櫃	MB2418 四櫃桶蒸櫃
尺寸 - 闊 × 深 × 高 Dimensions - W × D × H	(mm)	610 × 395 × 765	610 × 395 × 990	610 × 485 × 815
	(in)	24" × 15.5" × 30"	24" × 15.5" × 39"	24" × 19" × 32"
功率 Power	(w)	2 × 3,000	2 × 3,000	2 × 3,000
電壓 Voltage	(V)	220	220	220



MF22 / MF26.5 / MF29

- 304 不銹鋼網架
304 stainless steel tray
- 一體式不銹鋼抽手
Integrated stainless steel handle
- 不銹鋼外殼，堅固耐用
Stainless steel exterior Body, sturdy and durable
- 加厚內壁和底板
Thickened inner wall
- 自動彈回
Automatically bounce back
- 可調校較位
Adjustable position



聯品不銹鋼中式電焗爐 Luen Pun - Chinese Oven

型號 Model	MF22	MF26.5	MF29	
尺寸 - 闊 × 深 × 高 Dimensions - W × D × H	(mm)	558 × 508 × 410	675 × 508 × 410	740 × 610 × 485
	(in)	22" × 20" × 16"	26.5" × 20" × 16"	29" × 24" × 19"
功率 Power	(w)	2 × 1,500	2 × 2,000	4 × 1,500
電壓 Voltage	(V)	220	220	220

不銹鋼中式蒸櫃
STAINLESS STEEL CHINESE STEAM CABINET



GN9 (16"/ 29")



上: GN9 (玻璃門款) + 下: GN19

中式焗餅爐 Chinese Baking Oven

型號 Model	GN9-16 16 吋電焗餅爐	GN9-29 29 吋電焗餅爐	GN19 25 吋生鐵絞焗爐	
尺寸 - 闊 × 深 × 高 Dimensions - W × D × H	(mm)	410 × 410 × 365	740 × 610 × 435	635 × 558 × 380
	(in)	16" × 16" × 14"	29" × 24" × 17"	25" × 22" × 15"
功率 Power	(w)	3,000	2 × 3,000	2,500
電壓 Voltage	(V)	220	220	220



RN-2111D



RN-2109E



RN-2109EE / RN-2109EEP

利高牌電焗餅爐 LEEEO - Electric Cake Oven

型號 Model	RN-2111D 電焗餅爐 (鐵底)	RN-2109E 電焗餅爐 (鐵底)	RN-2109EE 程控電焗餅爐 (鐵底)	RN-2109EEP* 程控電批薩爐 (石板底)	
尺寸 - 闊 × 深 × 高 Dimensions - W × D × H	(mm)	810 × 718 × 490	820 × 870 × 415	820 × 870 × 415	
	(in)	32" × 28" × 19"	82" × 34" × 16"	82" × 34" × 16"	82" × 34" × 16"
功率 Power	(w)	5,000	5,000	5,000	5,000
電壓 Voltage	(V)	220	220	380	380



WF-318



WF369A



SR-GA421



KSH-D55



H013-HM13



SW-6000



SW-10000

木紋外殼
TS8000全不銹鋼外殼
SW-9600S

WF321

全不銹鋼外殼
TS8000S

TS-6000



WF323

電飯煲 Rice Cooker

型號 Model	尺寸 - 潤 × 深 × 高 Dimensions - W × D × H	容量 Volume		功率 Power	電壓 Voltage
	(mm)	(L)	碗 bowl	(w)	(V)
皇宮牌 PALACE					
WF316	395 × 345 × 310	3.6	10	1250	
WF317	430 × 380 × 330	4.2	20	1,550	
WF318	480 × 400 × 340	5.6	30	1,950	220
WF319	535 × 450 × 370	7.8	40	2,650	
WF320	570 × 485 × 385	9	50	2,950	
WF369A	470 × 390 × 380	6	33	1,950	220
WF370A	560 × 480 × 415	9	50	2,850	

樂聲牌 Panasonic

SR-UH36N	347 × 428 × 384	3.6	10	1,400	220
SR-GA421	483 × 483 × 483	4.2	20		

聲寶 Sharp

KSH-D55	467 × 322 × 411	5.5	45	1550	
KSH-D77	511 × 356 × 451	7	60	2000	220
KSH-D1010	587 × 364 × 529	10	100	1750	

象牌 Sunware

SW-5400	432 × 432 × 320	5.4	60	1,650	
SW-6000S	427 × 427 × 400	6	66	1,650	220
SW-10000	570 × 570 × 380	10	110	3,200	

聯品 Luen Pun

H013-HM14	∅385 × 815	12	50		
H013-HM18	∅460 × 815	15	80	3,000	220
H013-HM21	∅535 × 815	20	120		

暖飯煲 Rice Warmer

型號 Model	尺寸 - 潤 × 深 × 高 Dimensions - W × D × H	容量 Volume		功率 Power	電壓 Voltage
	(mm)	(L)	碗 bowl	(w)	(V)

象牌 Sunware

SW-9600S	432 × 432 × 462	6	60	88	220
----------	-----------------	---	----	----	-----

虎王牌 HUWANG

TS-8000	430 × 430 × 475	6	50	84~100	220
TS-8000S	480 × 370 × 460				
TS-10001S	380 × 380 × 390	10	110		無需插電
TS-10002S	360 × 360 × 370	6	50		No electricity required

皇宮牌 PALACE

WF321	480 × 400 × 340	6	33	1950	220
-------	-----------------	---	----	------	-----

暖湯煲 Soup Warmer

型號 Model	尺寸 - 潤 × 深 × 高 Dimensions - W × D × H	容量 Volume		功率 Power	電壓 Voltage
		(mm)	(L)	(w)	(V)
虎王牌	TS-6000	340 × 340 × 360	12	88	
Sunnex	81328	385 × 385 × 380	10	380	220
皇宮牌	WF323	340 × 340 × 360	10	400	



枱式平面小炒電磁爐 Desktop Induction Cooker



電源線
Power Cord
長 1.2m

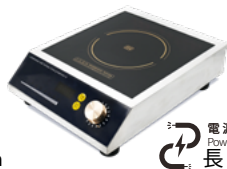

電源線
Power Cord
長 1.2m



電源線
Power Cord
長 1.2m



電源線
Power Cord
長 1.2m

型號 Model	TPX (加厚款)	TP	TP-5000	TP1
尺寸 - 闊 × 深 × 高 Dimensions - W × D × H (mm)	420 × 470 × 185	320 × 400 × 110	420 × 470 × 185	520 × 570 × 300
(in)	16.5" × 18.5" × 7"	13" × 16" × 4"	16.5" × 18.5" × 7"	20.5" × 22" × 12"
功率 Power (w)	3,500	3,500	5000	8,000
電壓 Voltage (V)	220	220	220	380



枱式凹面小炒電磁爐 Desktop Induction Wok Cooker



電源線
Power Cord
長 1.2m



電源線
Power Cord
長 1.2m

型號 Model	TA	TA-5000	TA1
尺寸 - 闊 × 深 × 高 Dimensions - W × D × H (mm)	420 × 470 × 235	420 × 470 × 235	520 × 570 × 300
(in)	16.5" × 18.5" × 9"	16.5" × 18.5" × 9"	20.5" × 22" × 12"
功率 Power (w)	3,500	5,000	8,000
電壓 Voltage (V)	220	220	380



多頭電磁爐 Induction Cooker



電源線 X2
Power Cord
長 1.2m



電源線 X4
Power Cord
長 1.2m



電源線 X2
Power Cord
含線頭線尾接駁位 2m;
實長 1.8m

型號 Mode	TP2 (前後雙頭)	TP4 (四頭)	TP6 (六頭)
尺寸 - 闊 × 深 × 高 Dimensions - W × D × H (mm)	400 × 800 × 220	750 × 800 × 270	1100 × 800 × 270
(in)	16" × 31" × 9"	30" × 31" × 11"	43" × 31" × 11"
功率 Power (w)	3,500 × 2	3,500 × 4	3,500 × 6
電壓 Voltage (V)	220	220	380



多頭電磁爐 (背擋) Induction Cooker (with baffle)



電源線 X4
Power Cord
長 1.2m



電源線 X2
Power Cord
含線頭線尾接駁位 2m;
實長 1.8m

型號 Model	TP4 (四頭配背擋)	TP6 (六頭配背擋)
尺寸 - 闊 × 深 × 高 Dimensions - W × D × H (mm)	750 × 800 × 270 + 50	1100 × 800 × 270 + 50
(in)	30" × 31" × 11" + 2"	43" × 31" × 11" + 2"
功率 Power (w)	3,500 × 4	3,500 × 6
電壓 Voltage (V)	220	380

電磁爐與工作台組合展示 Combination Display



* 可訂製有背擋或無背擋
Tail-made backslash

* 凹面電磁爐配有專用炒鑊
Specified wok use only

產品不斷改良，如有更改，均以實物為準。
Products are subject to change due to enhancements and continuous development.

單頭單尾凹面小炒電磁爐
Induction Wok Hob

型號 Model	尺寸 - 濶 × 深 × 高 Dimensions - W × D × H		功率 Power (w)	電壓 Voltage (V)
	(mm)	(in)		
X400	1150 × 900 × 800+400	42.5" × 35.5" × 31"+16"	12,000	380
X500	1150 × 900 × 800+400	42.5" × 35.5" × 31"+16"	15,000	380

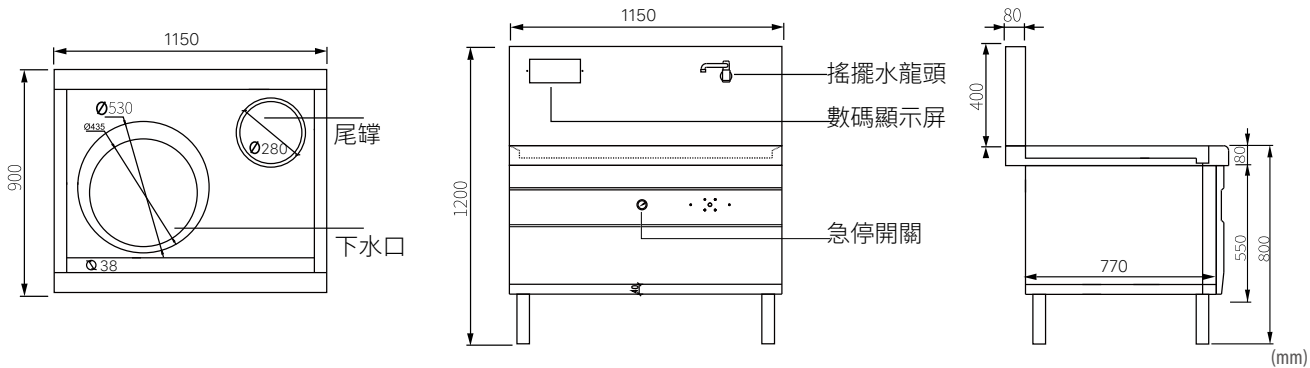

 電源線
 Power Cord
 長 2m

單頭無尾凹面電磁炒爐
Induction Wok Hob

型號 Model	尺寸 - 濶 × 深 × 高 Dimensions - W × D × H		功率 Power (w)	電壓 Voltage (V)
	(mm)	(in)		
DX120	800 × 800 × 800+400	31.5" × 31.5" × 31"+16"	12,000	380
DX150	800 × 800 × 800+400	31.5" × 31.5" × 31"+16"	15,000	380

 電源線
 Power Cord
 長 2m

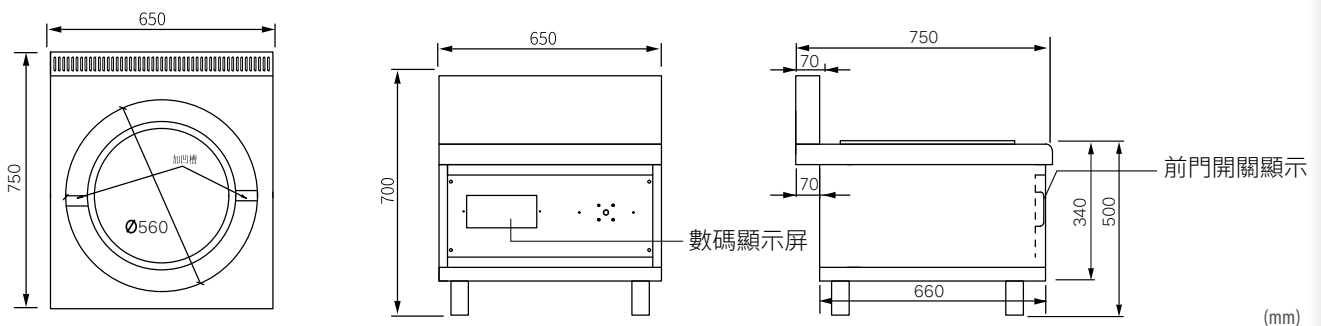
平頭煲湯爐電磁爐
Induction Stock Pot Cooker

型號 Model	尺寸 - 濶 × 深 × 高 Dimensions - W × D × H		功率 Power (w)	電壓 Voltage (V)
	(mm)	(in)		
P420	650 × 750 × 500+200	24" × 26" × 20"+8"	12,000	380
P420-1	650 × 750 × 500+200	24" × 26" × 20"+8"	15,000	380

 電源線
 Power Cord
 長 2m

商業用 For Business

- 電磁爐傳熱效率高、節省電力
Induction cooking is faster and saves times.
- 煮食後爐面的溫度也相對較低
Cooktops remain cool to the touch after cooking



IC-S2006K



IC-S2500T



IC-S2700



IC-S3501



IC-S3001

德國卓爾電磁爐 Summe - Induction Cooker

型號 Model	尺寸 - 潤 × 深 × 高 Dimensions - W × D × H		功率 Power (w)	電壓 Voltage (V)
	(mm)	(in)		
IC-S2006K	287 × 350 × 68	11" × 14" × 3"	2,000	220
IC-S2500T	303 × 373 × 76	12" × 15" × 3"	2,500	220
IC-S2700	300 × 379 × 100	12" × 15" × 4"	2,700	220-240
IC-S3001	330 × 420 × 105	13" × 17" × 4"	3,000	220-240
IC-S3501	327 × 490 × 100	13" × 19" × 4"	3,500	220-240



IH-S308



IH-S72

家美牌電磁爐 Homey - Induction Cooker

型號 Model	尺寸 - 潤 × 深 × 高 Dimensions - W × D × H		功率 Power (w)	電壓 Voltage (V)
	(mm)	(in)		
IH-S308	280 × 360 × 43	11" × 14" × 2"	2,100	220
IH-S72	280 × 345 × 65	11" × 14" × 3"	2,200	220

商業用 For Business

HOMEY

CH-96



CH-SS8



CH-8800

家美牌電陶爐 Homey - Electronic Ceramic Cooker

型號 Model	尺寸 - 潤 × 深 × 高 Dimensions - W × D × H		功率 Power (w)	電壓 Voltage (V)
	(mm)	(in)		
CH-96	280 × 340 × 60	11" × 13" × 2"	2,200	220
CH-SS8	360 × 280 × 65	14" × 11" × 3"	2,200	220
CH-8800	310 × 390 × 56	12" × 15" × 2"	2,400	220

Austbo
 歐之寶

C-5



AT-2800 / AT-3600



A168

歐之寶電陶爐 Austbo - Electronic Ceramic Cooker

型號 Model	尺寸 - 潤 × 深 × 高 Dimensions - W × D × H		功率 Power (w)	電壓 Voltage (V)
	(mm)	(in)		
C-5	260 × 360 × 60	10" × 14" × 2"	2,100	220
AT-2800	330 × 430 × 115	13" × 17" × 4.5"	2,800	220
AT-3600	430 × 330 × 115	17" × 13" × 4.5"	3,600	220
A168	360 × 290 × 75	14" × 11" × 3"	2,000	220

德國卓爾電陶爐 Summe - Electronic Ceramic Cooker

型號 Model		IC-S2003C
尺寸 - 潤 × 深 × 高 Dimensions - W × D × H	(mm)	290 × 372 × 55
	(in)	11" × 15" × 2"
功率 Power	(w)	2,000
電壓 Voltage	(V)	220



IC-S2003C

多寶牌電陶爐 - Dorbo - Electronic Ceramic Cooker

型號 Model		DR-J8
尺寸 - 潤 × 深 × 高 Dimensions - W × D × H	(mm)	280 × 360 × 68
	(in)	11" × 14" × 3"
功率 Power	(w)	2,000
電壓 Voltage	(V)	220



DR-J8

MADE IN TAIWAN
台灣製造



TS-103
三層九盤烤箱



TS-113
家庭式發酵箱



TS-105
三層三盤烤箱



TS-104
二層烤箱 + 焗爐架



台灣烘焙焗爐 Taiwanese Baking Oven

型號 Model	尺寸 - 潤 × 深 × 高 Dimensions - W × D × H				功率 Power (w)	電壓 Voltage (V)
	外寸 Outer		內寸 Inner			
	(mm)	(in)	(mm)	(in)		
TS-103	1900 × 950 × 1680	75" × 37.5" × 66.5"	1460 × 760 × 200	57.5" × 30" × 8"	27,000	380
TS-104	1430 × 950 × 1680	56.5" × 37.5" × 66.5"	970 × 760 × 200	38.5" × 30" × 8"	18,000	380
TS-105	1140 × 810 × 1590	45" × 32" × 62.5"	760 × 520 × 200	30" × 20.5" × 8"	12,000	380
TS-113	690 × 520 × 710	27" × 20.5" × 28"	-	-	1,000	220

產品不斷改良，如有更改，均以實物為準。
Products are subject to change due to enhancements and continuous development.



T043M0HAJR



FC 60 / FC 60 TQ



FC110EG



FCV280



FC280



FC380TQ

對衡式焗爐 Convection Oven

型號 Model		尺寸 - 闊 × 深 × 高 Dimensions - W × D × H				功率 Power (w)	電壓 Voltage (V)
		外尺寸 Outer		內尺寸 Inner			
		(mm)	(in)	(mm)	(in)		
Venix	T043M0HAJR	560 × 632 × 575	22" × 25" × 23"	474 × 380 × 365	19" × 15" × 14"	2,900	220
Roller Grill	FC60	595 × 610 × 590	23.5" × 24" × 23.5"	470 × 370 × 350	18.5" × 14.5" × 14"	3,000	230
Roller Grill	FC60TQ	595 × 610 × 590	23.5" × 24" × 23.5"	470 × 370 × 350	18.5" × 14.5" × 14"	3,000	230
Roller Grill	FC110EG	795 × 755 × 595	31.5" × 30" × 23"	670 × 440 × 350	26.5" × 17.5" × 14"	6,000	380
Roller Grill	FCV280	370 × 535 × 495	14.5" × 21" × 19.5"	260 × 330 × 320	10" × 13" × 13"	1,500	230
Roller Grill	FC280	460 × 550 × 355	18" × 21.5" × 14"	315 × 315 × 265	12" × 12" × 10"	1,500	230
Roller Grill	FC380TQ	550 × 550 × 355	21.5" × 21.5" × 14"	415 × 350 × 265	16" × 14" × 10"	2,600	230

另有更多 Roller Grill 焗爐，請參閱第 46 頁的「多功能焗爐 Multifunctions Oven」。
For more Roller Grill products, please see “多功能焗爐 Multifunctions Oven” on page 46.

產品不斷改良，如有更改，均以實物為準。
Products are subject to change due to enhancements and continuous development.



- 兼具蒸、煮、烤、炸、燉、烘功能
The functions of steaming, boiling, roasting, frying, stewing and baking
- 智慧烹調功能
Smart cooking function

- 自動清洗裝置
Automatic cleaning device



iCombi Pro | 四大助手 functional features

iProductionManager 產能提升

幫助您智能靈活地組織點菜、現場調度和複雜的生產運行。
It can help you organize a la carte, mise en place and complex production runs intelligently and flexibly.

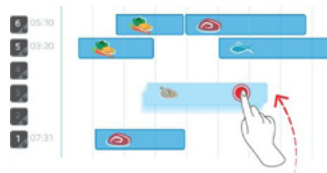

iCareSystem+ 自動清洗

iCookingSuite 智慧烹飪功能

iDensityControl 品質穩定



ICOMBI PRO XS 6-2/3 E

iCombi Classic | 操作簡單，易懂屏幕符號跟直覺性設計讓您短時間就能上手 It can all be controlled. Simply and intuitively



個性化編成
Individually programmable.



熱空氣運行模式
Convection mode.



組合運行模式
Combination mode.



蒸氣運行模式
Steam Mode.

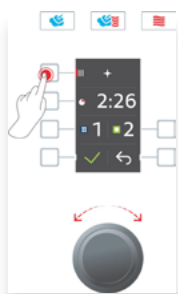

所有清潔階段都可以在顯示屏上快速輕鬆地選擇。
All the cleaning stages are quick and easy to select on the display.



ICOMBI CLASSIC 6-1/1 E



ICOMBI CLASSIC 10-1/1 E



ICOMBI CLASSIC 20-1/1 E

德國 Rational 多用途蒸焗爐 Rational Combi Oven

型號 Model	有效容量 Validity Capacity	尺寸 (包括門把) - 闊 × 深 × 高 Dimensions (including door handle) - W × D × H		縱向裝載層 Lengthwise loading	熱風輸出功率 Power "Hot air" output	蒸氣輸出功率 Power "Steam" output	電壓 Voltage
		(mm)	(in)				
iCombi Pro XS 6-2/3	6 x 2/3 GN	655 × 621 × 567	26" × 24" × 22"	1/2, 2/3, 1/3, 2/8	5,400	5,400	400V-3N
iCombi Classic 6-1/1 E	6 x 1/1 GN	850 × 842 × 754	33.5" × 33" × 30"		10,300	9,000	400V-3N
iCombi Classic 10-1/1 E	10 x 1/1 GN	850 × 842 × 1014	33.5" × 33" × 40"	1/1, 1/2, 2/3, 1/3, 2/8	18,000	18,000	400V-3N
iCombi Classic 20-1/1 E	20 x 1/1 GN	879 × 791 × 1782	35" × 31" × 70"		36,000	36,000	400V-3N

產品不斷改良，如有更改，均以實物為準。
Products are subject to change due to enhancements and continuous development.

意大利 VENIX 智能蒸烤焗爐 VENIX Combi Steam Oven

- 溫度記憶
Core probe regeneration
- 時間記憶
Timed regeneration
- 晚間煮食和清洗
Overnight cooking & washing
- 煮食和保溫
Cooking & hold
- 自動冷卻
Automatic cool-down
- 分層混合煮食
Multi-level mix
- 自動清洗
Self cleaning
- ¹ 沖洗
Rinsing

* 1 只限 SM07TCC 或以上型號
For SM07TCC or above models only



VENEXIA CLOUD

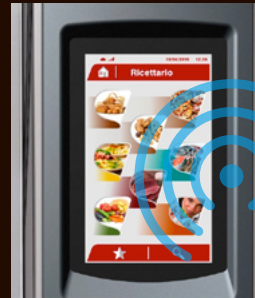

雲端食譜
RECIPE PLATFORM



跨平台食譜分享
RECIPE SHARING ON
MULTIPLE DEVICES



雲端服務
CLOUD SERVICE



型號 Model		SM05TCC	SM07TCC	SM12TCC	SM20TCC	SM40TCC
有效容量 Validity Capacity		5 × GN 1/1	7 × GN 1/1	12 × GN 1/1	20 × GN 1/1	40 GN 1/1 – 20 GN 2/1
尺寸 – 闊 × 深 × 高 Dimensions – W × D × H (without handle)	(mm)	792 × 1029 × 781	792 × 1021 × 941	792 × 1021 × 1277	1091 × 1006 × 1900	1091 × 1252 × 1900
	(in)	31" × 40.5" × 31"	31" × 40" × 37"	31" × 40" × 50"	43" × 40" × 75"	43" × 49" × 75"
層架相隔空間 Space between trays	(mm)	75	75	75	66	66
功率 Power	(w)	9,400	10,800	16,100	28,600	43,600
電壓 Voltage	(V)	380	380	380	380	380
溫度 Temperature	(°C)	280	280	280	280	2870
焗爐重量 Oven Weight	(kg)	92	100	134	250	350

產品不斷改良，如有更改，均以實物為準。
Products are subject to change due to enhancements and continuous development.

SQUERO DIGITAL

- 記憶設置 (0-99)
Cooking programs (0-99)
- 雙向換風系統
Bi-directional fan system
- 電子注水調節
Digital water injection regulation
- 自動預熱設置
Automatic pre-heating setting
- 2 段速度調節
2 speed regulation
- 蒸氣排氣調節
Steam Exhaust regulation
- 鹵素燈
Halogen lights
- 食物溫度探針
Core probe



SQ20D0C*/ SQ40D0C*



SQ12D00/DGC*



SQ07D00/ DGC*



SQ05D00/ DGC*



SQ053D00/ D0C*

型號 Model	有效容量 Validity Capacity	尺寸 (不包括門把手) - 闊 × 深 × 高 Dimensions (without handle) - W × D × H		層架相隔空間 Space between trays (mm)	功率 Power (w)	電壓 Voltage (V)	最高溫度 Max cooking Temperature (°C)	重量 Unit Weight (kg)
		(mm)	(in)					
SQ053D00	5 × GN 2/3	701 × 780 × 625	28" × 31" × 25"	66	5,300	380	260	55
SQ053D0C*								
SQ05D00	5 × GN 1/1	937 × 885 × 715	37" × 35" × 28"	70	10,600	380	260	88
SQ05DGC*								
SQ07D00	7 × GN 1/1	937 × 885 × 875	37" × 35" × 34"	70	10,600	380	260	98
SQ07DGC*								
SQ12D00	12 × GN 1/1	937 × 827 × 1211	37" × 33" × 48"	70	15,800	380	260	135
SQ12DGC*								
SQ20D0C*	20 × GN 1/1	1051 × 1002 × 1900	41" × 39" × 75"	66	28,100	380	260	250
SQ40D0C*	40 GN1/1	1051 × 1184 × 1900	41" × 47" × 75"	67	43,600	400	260	287

萬用蒸烤焗爐 COMBI STEAM OVEN

- 記憶設置 (0-99)
Cooking programs (0-99)
- 雙向換風系統
Bi-directional fan system
- 電子注水調節
Digital water injection regulation
- 自動預熱設置
Automatic pre-heating setting
- 2 段速度調節
2 speed regulation
- 蒸氣排氣調節
Steam Exhaust regulation
- 鹵素燈
Halogen lights
- 食物溫度探針
Core probe



R063DGC



- 記憶設置 (0-99)
Cooking programs (0-99)
- 雙向換風系統
Bi-directional fan system
- 電子注水調節
Digital water injection regulation
- 自動預熱設置
Automatic pre-heating setting
- 2 段速度調節
2 speed regulation
- 蒸氣排氣調節
Steam Exhaust regulation
- 鹵素燈
Halogen lights



R063M0N0



型號 Model	有效容量 Validity Capacity	尺寸 - 闊 × 深 × 高 Dimensions - W × D × H		層架相隔空間 Space between trays (mm)	功率 Power (w)	電壓 Voltage (V)	最高溫度 Max cooking Temperature (°C)	重量 Oven Weight (kg)
		(mm)	(in)					
R063DGC	6 GN 2/3 h=40mm 4 GN 2/3 h=65mm	532 × 738 × 748	21" × 29" × 29"	46 for trays h=40mm 92 for trays h=65mm	5,300	400	260	63
R063M0N0	6 GN 2/3 h=40mm 4 GN 2/3 h=65mm	532 × 738 × 748	21" × 29" × 29"	46 for trays h=40mm 92 for trays h=65mm	5,300	400	260	63

* 結合自動清潔系統
Automatic clean system integrated

gemini
ITALY

GSO17G



GOG35S



GOG45S



GSO20



GSO40



GOV25



GOV35

Gemini 焗爐 Gemini - Oven

型號 Model	尺寸 - 闊 × 深 × 高 Dimensions - W × D × H		功率 Power	有效容量 Validity Capacity	電壓 Voltage
	(mm)	(in)			
GSO17G	481 × 340 × 465	19" × 13" × 18"	1,700	26	220
GOG35S	353 × 465 × 407	14" × 18" × 16"	1,500	35	220
GOG45S	359 × 608 × 407	14" × 24" × 16"	2,000	45	220
GSO20	346 × 440 × 463	14" × 17" × 18"	2,000	20	220
GSO40	370 × 525 × 520	14.5" × 21" × 20"	2,100	40	220
GOV25	343 × 465 × 303	13.5" × 18" × 12"	1,600	25	220
GOV35	522 × 327 × 381	20.5" × 13" × 15"	1,600	35	220

HOMEY

PRO-M20



PRO-M36



PRO-M38D



PRO-M45

家美牌焗爐 Homey - Oven

型號 Model	尺寸 - 闊 × 深 × 高 Dimensions - W × D × H		功率 Power	有效容量 Validity Capacity	電壓 Voltage
	(mm)	(in)			
PRO-M20	420 × 354 × 285	16.5" × 14" × 11"	1,300	20	220
PRO-M36	503 × 420 × 350	20" × 16.5" × 14"	1,500	36	220
PRO-M45	568 × 412 × 350	22" × 16" × 14"	2,000	45	220
PRO-M38D	503 × 435 × 355	20" × 17" × 14"	1,800	38	220



TO-S211



TO-S33CF



TO-S48CF

德國卓爾焗爐 Summe - Oven

型號 Model	尺寸 - 闊 × 深 × 高 Dimensions - W × D × H		功率 Power	有效容量 Validity Capacity	電壓 Voltage
	(mm)	(in)			
TO-S211	425 × 284 × 355	17" × 11" × 14"	1,200	21	220
TO-S33CF	520 × 330 × 350	20.5" × 13" × 14"	1,500	33	220
TO-S48CF	550 × 360 × 440	22" × 14" × 17"	2,000	48	220



MW-S200

德國卓爾微波爐 Summe- Microwave Oven

型號 Model	尺寸 - 潤 × 深 × 高 Dimensions - W × D × H		功率 Power (w)	有效容量 Validity Capacity (L)	電壓 Voltage (V)
	(mm)	(in)			
MW-S200	451 × 257 × 350	18" × 10" × 14"	700	20	220

**Panasonic
樂聲牌**



NN-SM33H



NN-ST34H



NN-ST65JM



NE-1753



NE-1037



NN-ST34N



NN-SM33N

樂聲牌微波爐 Panasonic - Microwave Oven

型號 Model	尺寸 - 潤 × 深 × 高 Dimensions - W × D × H		功率 Power (w)	有效容量 Validity Capacity (L)	電壓 Voltage (V)
	(mm)	(in)			
NE-1037	306 × 510 × 360	12" × 20" × 14"	950	22	230
NE-1753	337 × 422 × 508	13" × 17" × 20"	1700	18	230
NN-SM33H	287 × 485 × 400	11" × 19" × 16"	800	25	220
NN-ST34H	287 × 485 × 400	11" × 19" × 16"	800	25	220
NN-ST65JM	310 × 525 × 388	12" × 21" × 15"	1,000	32	220
NN-ST34N	280 × 469 × 380	11" × 18.5" × 15"	900	25	220
NN-SM33N	280 × 469 × 380	11" × 18.5" × 15"	900	25	220



SCEO23AB



SMW20VDAB

施耐德微波爐 Schneider- Microwave Oven

型號 Model	尺寸 - 潤 × 深 × 高 Dimensions - W × D × H		功率 Power (w)	有效容量 Validity Capacity (L)	電壓 Voltage (V)
	(mm)	(in)			
SCEO23AB	390 × 480 × 335	15" × 19" × 13"	1,500	23	220
SMW20VDAB	257 × 451 × 359	10" × 18" × 14"	1,150	20	220



69192



69302



西班牙 Lacor 慢煮棒 Lacor - Vide Gourmet

型號 Model		69192	69302
最大容量 Cooking Capacity	(l)	25	15
尺寸 - 闊 × 深 × 高 Dimensions - W × D × H	(mm)	140 × 140 × 330	100 × 100 × 370
功率 Power	(w)	1,400	800
溫度 Temperature	(°C)	5 ~ 99 (±0.1)	20 ~ 100 (±1)
速度 Speed	(Lts/ min.)	6	8.5

- 強力循環水泵保持水溫穩定
Strong circulating pump ensures optimum temperature stability
- 防缺水系統
Warning system for low water level



PEARL 9FT1000



DIAMOND 9FT2000



德國 Fusion Chef 慢煮棒 Fusion Chef - Sous Vide Cooker

型號 Model		PERAL 9FT1000	DIAMOND 9FT2000
最大容量 Cooking Capacity	(l)	58	58
水深 Immersion depth	(mm)	165	165
尺寸 - 闊 × 深 × 高 Dimensions - W × D × H	(mm)	133 × 212 × 330	133 × 212 × 330
溫度範圍 Temperature range	(°C)	20 ~ 95 (±0.03)	20 ~ 95 (±0.01)
功率 Power	(w)	2,000	2,000
電壓 Voltage	(V)	230	230
重量 Weight	(kg)	4.5	5



ELITE 300 PLUS



JUMBO 30



AXOLUTE



Magic Vac 抽真空機 Magic Vac Vacuum Pack Machine

型號 Model	機身尺寸 - 闊 × 深 × 高 Dimensions - W × D × H (mm)	封條 Seal bar (mm)	功率 Power (w)	真空泵排氣量 Vacuum capacity (L/Min)	電壓 Voltage(V)	重量 Weight(kg)
ELITE 300 PLUS	387 × 96 × 115	300	140	9	230	1.7
AXOLUTE	440 × 240 × 110	300	130	10	220	3.8
JUMBO 30	415 × 245 × 125	340	130	28	220	5



- 記憶設置
Program memory
- 時間控制
Time control
- 真空泵清洗設置
Pump cleaning program



MINI JUMBO



JUMBO 30



JUMBO 42



BOXER 42

荷蘭 Henkelman 抽真空機 Henkelman Vacuum Pack Machine

型號 Model	機身 - 闊 × 深 × 高 Machine - W × D × H (mm)	機室 - 闊 × 深 × 高 Chamber - W × D × H (mm)	封條 Seal bar (mm)	功率 Power (w)	真空泵排氣量 Pump capacity(m ³ /hr)	電壓 Voltage(V)	重量 Weight(kg)
MINI JUMBO	335 × 450 × 305	310 × 280 × 85	263	100	4	230	26
JUMBO 30	450 × 555 × 365	370 × 350 × 150	350	400~500	8	230	44
JUMBO 42	530 × 490 × 440	370 × 420 × 180	410	600	16	230	58
BOXER 42	530 × 490 × 440	370 × 420 × 180	410	800~1000	21	230	64



12S

意大利 fimar 絞肉機 fimar - Meat Mincers



型號 Model	尺寸 - 潤 × 深 × 高 Dimensions - W × D × H (mm)	功率 Power (w)	其他 Others
12S	400 × 250 × 500	750	不銹鋼 / 鑄鐵推進器
22SN	450 × 290 × 520	1,100	不銹鋼 / 鑄鐵推進器
22C	410 × 270 × 450	1,100	全不銹鋼
32RS	490 × 340 × 530	2,200	全不銹鋼



MX25

FX40

MX40

意大利 fimar 手提攪拌棒 fimar - Handheld Mixer

型號 Model	尺寸 Dimensions - L × L × H (mm)	功率 Power (w)	轉速 Motor speed (rpm)	可攪拌容量 *1 Holding capacity (L)	標準攪棍長度 Default mixer length (mm)
MX25	135 × 100 × 600	250	13,000	30	300
MX40	155 × 120 × 710/790	400	2,500 ~ 11,000 250 ~ 1,500	60	400
MX42S	170 × 120 × 740	400	11,000	60	400
FX40	170 × 120 × 660/740	400	2,500 ~ 11,000 250 ~ 1,500	60	350 - 打蛋器

* 另備有不同攪棍長度，歡迎查詢
Different size of Blender tube for options

*1 根據標準攪棍長度
Base on default mixer length



BC3N



CL5 / CL8

意大利 fimar 粉碎機 fimar - Cutter Mixer

型號 Model	尺寸 - 潤 × 深 × 高 Dimensions - W × D × H (mm)	功率 Power (w)	轉速 Motor speed (rpm)	可攪拌容量 Holding capacity (L)	最大可攪拌量 Max capacity in tank (L)	攪拌碗尺寸 Bowl size - Ø × H (mm)	其他 Others
BC3N	520 × 320 × 620	370	1,300	3	1.7	Ø210 × 110	
CL5	240 × 310 × 570	750	1,400	5	2.1	Ø210 × 160	可攪蔬菜、生果、堅果、肉類
CL8	240 × 310 × 620	750	1,400	8	2.4	Ø210 × 205	



PPN5

意大利 fimar 薯仔去皮機 fimar - Potato Peeler

型號 Model	尺寸 - 潤 × 深 × 高 Dimensions - W × D × H (mm)	功率 Power (w)	每小時產量 Hourly Production (kg/h)	容器容量 Bowl Capacity (kg)
PPN5	520 × 630 × 590	370	60	5
PPN10M	400 × 770 × 860	750	120	10
PPN18M	400 × 770 × 930	1,100	220	18



TS12



TS22



TI22R



TI32R

意大利 FAMA 絞肉機 FAMA - Meat Mincers

型號 Model	尺寸 - 濶 × 深 × 高 Dimensions - W × D × H (mm)	功率 Power (w)	轉速 Screw revolution (rpm)	機身 body	推進器 Screw
TS12	220×370×440	750	200	鑄鋁	合金 / 不銹鋼
TS22	240×440×510	1,100	140	鑄鋁	合金 / 不銹鋼
TI22R	260×450×530	1,500	140	不銹鋼	不銹鋼
TI32R	300×475×560	2,200	140	不銹鋼	不銹鋼



意大利 FAMA 漢堡壓 FAMA - Presshamburger

型號 Model	尺寸 - 濶 × 深 × 高 Dimensions - W × D × H (mm)	直徑 Cylinder (mm)	漢堡重量 Hamburger weight (g)	重量 Net weight (kg)
FHA 100	190×250×320	Ø100	70 ~ 150	4.5



FHA100



意大利 FAMA 腸機 FAMA - Sausage Fillers

型號 Model	尺寸 - 濶 × 深 × 高 Dimensions - W × D × H (mm)	容量 Capacity (L)	其他 Others
L70 (水平)	230×800×240	7	15, 23, 28, 38 mm 咀 (跟機)
L7V (垂直)	300×460×740		



L70

L7V



MADE IN ITALY
意大利製造



FM250VF250

FM250VV250



另有專用配件
可供選購
OPTIONAL

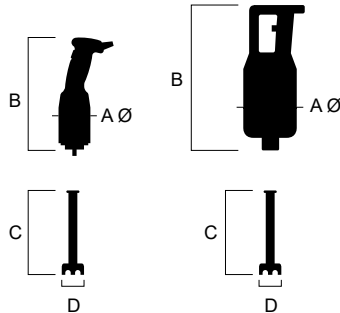

FM350VF400

定速
Fix speed



另有專用配件
可供選購
OPTIONAL



FM450VV400

可調速
Variable speed

意大利 FAMA 手提攪拌棒 FAMA - Handheld Mixer

型號 Model	機身 + 攪棒尺寸 Body+Tube dimensions (mm)				功率 Power (w)	轉速 Motor speed (rpm)	可攪拌容量 *1 Holding capacity (L)	機身 + 攪棒重量 Body+Tube weight (kg)
	A	B	C	D				
FM250VF250 輕型定速攪棒	Ø75	285	270	75	250	15,000	20	1.45
FM250VV250 輕型變速攪棒	Ø75	285	270	75	250	2,500 ~ 15,000	20	1.45
FM350VF400 重型定速攪棒	Ø130	360	440	85	350	15,000	50/80	3.6
FM450VV400 重型變速攪棒	Ø130	380	440	85	450	2,000/11,000~17,000	100	4.2

* 另備有不同攪棍長度，歡迎查詢
Different size of Blender tube for options

*1 根據標準攪棍長度
Base on default mixer length



FAFG253E



FAFG303E

意大利 FAMA 切片機 FAMA - Slicer

型號 Model	尺寸 - 濶 × 深 × 高 Dimensions - W × D × H	功率 Power	刀片直徑 Blade size		最大切割厚度 Maximum cutting thickness
	(mm)		(w)	(mm)	
FAFG253E	490 × 430 × 400	185	Ø250	Ø9.8	0 - 15
FAFG303E	500 × 480 × 440	260	Ø300	Ø11.8	0 - 15

產品不斷改良，如有更改，均以實物為準。
Products are subject to change due to enhancements and continuous development.

robot coupe®

MADE IN FRANCE
法國製造



MICROMIX



MINI MP 240 V.V.



MP 350 ULTRA



MP 450 ULTRA



MP 550 ULTRA

法國 Robot Coupe 手提攪拌棒 Robot Coupe - Handheld Mixer

型號 Model	尺寸 - Ø 直徑 × 長 Dimensions - Diameter (Ø) × Length (mm)	功率 Power (w)	轉速 Motor speed (rpm)	重量 Net weight (kg)
MicroMix	Ø 61 × 430	220	1,500 ~ 14,000	1
Mini MP 240 V.V.	Ø 78 × 535	290	2,000 ~ 12,500	1.5
MP 350 ULTRA	Ø 125 × 740	440	9,500	4.6
MP 450 ULTRA	Ø 125 × 840	500	9,500	5
MP 550 ULTRA	Ø 125 × 940	750	9,000	5.2

* 另備有不同攪棍長度，歡迎查詢
Different size of Blender tube for options



J80



BLIXER 3



CL 50 ULTRA



R2



R3-1500



R3-3000



R 301 ULTRA



R 402 V.V.

法國 Robot Coupe 蔬果處理器 / 粉碎機 Robot Coupe - Cutter and Vegetable slicer

型號 Model	機身尺寸 - 潤 × 深 × 高 Body dimensions - W × D × H (mm)	切割容器容量 Cutter bowl capacity (L)	功率 Power (w)	轉速 Motor speed (rpm)	重量 Net weight (kg)
J 80	235 × 538 × 500	6.5	700	-	11
Blixer 3	240 × 305 × 445	3.7	750	3,000	12
CL 50 Ultra	380 × 305 × 595	2.2	550	375	18
R 2	200 × 280 × 350	2.9	550	1,500	9
R 3 1500	320 × 210 × 400	3.7	650	1,500	10
R 3 3000	210 × 320 × 400	3.7	650	3,000	12
R 301 Ultra	355 × 305 × 570	3.7	650	1,500	19
R 402 V.V.	320 × 305 × 590	4.5	1,000	300 ~ 3,500 (切割) 300 ~ 1,000 (蔬菜處理)	22

產品不斷改良，如有更改，均以實物為準。
Products are subject to change due to enhancements and continuous development.



MD 95



DMX 160



DMX 160 V2



JUNIOR MX 225



SENIOR COMBI 300



SMX 600 TURBO



SMX 800 TURBO

法國 Dynamic 手提攪拌棒 Dynamic - Handheld Mixer

型號 Model	尺寸 dimensions (mm)			功率 Power (w)	轉速 Motor speed (rpm)	可攪拌容量 Capacity (L)	重量 Weight(kg)
	總長度 Total length	軸長 Shaft length	機身直徑 Diameter Ø				
MD 95	445	160	72	250	11,500	1~8	1.2/ 1.5
DMX 160	395	160	70	220	3,000~13,000	1~4	1/ 1.2
DMX 160 V2	395	160	55	220	8,000/ 13,000	1~4	1/ 1.2
JUNIOR MX 225	505	255	94	270	3,000~12,000	1~25	1.1/ 1.9
SENIOR COMBI 300	640	300	97	350	9,500	5~20	2.5
SMX 600 TURBO	800	530	125	850	11,000	75~300	6.1
SMX 800 TURBO	960	680	125	1000	11,000	75~300	6.7



E10



E20

法國 Dynamic 手動沙律脫水機 Dynamic - Salad Spinner

型號 Model	尺寸 - 直徑 × 高 Dimensions - Ø × H (mm)	容量 Capacity (L)	重量 Weight (kg)
E10	Ø 330 × 420	10	2.4 / 3
E20	Ø 430 × 500	20	3.6 / 4

手動式多功能切片機，不僅能切絲、切片，配合特製刀片更可以切成網狀或網中小魚的圖案。



切絲



切片

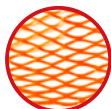

漁網



網中小魚

手動切絲、切片機 Tsumataro garnish cutter

型號	Model		CB106011
尺寸	Dimensions	(mm)	300×250×170
重量	Weight	(kg)	1.9
食材最大直徑	Max. diameter	(mm)	100
食材最大闊度	Max. width	(mm)	120

只需簡單步驟便可創出絲條。



1 mm



2.5 mm



4 mm

手動刨絲機 (豪華型) Tsumakirikun garnish cutter

型號	Model		CB106018
尺寸	Dimensions	(mm)	370×135×210
重量	Weight	(kg)	1.1
食材最大直徑	Max. diameter	(mm)	130
食材最大闊度	Max. width	(mm)	150

將手柄連接軸插入椰菜內，調整厚度，轉動手柄便能創出細緻的菜絲。



紫甘藍絲



椰菜絲

手動椰菜刨絲機 Manual cabbage slicer

型號	Model		CB104005
尺寸	Dimensions	(mm)	240×220×300 x
重量	Weight	(kg)	1.8
食材最大直徑	Max. diameter	(mm)	∅220
厚度	Thickness	(mm)	~2.5
處理能力	Process ability		每個 2分鐘

將大蔥切成小段和去芯，然後放進入口，輕鬆轉動手柄便能切成幼絲。



大蔥絲



青蔥絲

手動蔥絲機 (需去芯) Shiraga 2000 (No core type)

型號	Model		CB105051
尺寸	Dimensions	(mm)	195×240×255
重量	Weight	(kg)	2
食材最大直徑	Max. diameter	(mm)	22×27
厚度	Thickness	(mm)	1.5
處理能力	Process ability		2 kg / 10分鐘

馬達和刀片可輕易取出，方便清潔。



電動



大蔥絲



青蔥絲

電動蔥絲機 (連芯) Electric Shiraga 2000 (Core type)

型號	Model		CB105050
尺寸	Dimensions	(mm)	200×370×375
重量	Weight	(kg)	5.5
切絲厚度	Size of green onion	(mm)	3
處理能力	Process ability		3 kg / 5分鐘
電壓	Voltage	(V)	110

輕巧細小的電動磨蓉機，馬力強大。



蒜蓉



蘿蔔蓉



電動

電動磨蓉機 Super Oroshimaru

型號	Model		CB104027
尺寸	Dimensions	(mm)	180×270×310
重量	Weight	(kg)	3.0
功率	Power	(w)	120
處理能力	Process ability		20秒 (半個 ∅50 mm 蘿蔔)
連續使用時間	Usage time	(min)	10



滑動式V型刀片，可拆卸刀架方便清潔。



幼椰菜絲 蓮藕片 洋蔥片

多功能手動切絲、切片機 High Slice

型號	Model		CB103012
尺寸	Dimensions	(mm)	380×260×220
重量	Weight	(kg)	2.4
最大可用尺寸	Size of insert	(mm)	109×53~160
切片厚度	Thickness	(mm)	0.5 ~ 15

120 mm 闊刀片
方便將大型蔬果切片切絲。



蕃茄片 青瓜片 紅蘿蔔絲

切片、切絲器 Sengiri Sliceun

型號	Model		CB103191
尺寸	Dimensions	(mm)	350×145×28
重量	Weight	(kg)	0.45
切割闊度	Max. width	(mm)	120
厚度	Thickness	(mm)	~ 3
附件	Attachment		1.0 mm、2.5 mm 刀片

可更換切片圓盤來改變切出食材的厚度。



檸檬片 幼椰菜絲
蓮藕片 洋蔥片

電動多功能切絲切片機 Vegg Slicer

型號	Model		CB104190
尺寸	Dimensions	(mm)	310×320×516
重量	Weight	(kg)	6.4
功率	Power	(w)	40
轉速	Speed	(rpm)	148
連續使用時間	Usage time	(min)	30
電壓	Voltage	(V)	110



電動



高效能手動蔥機有3種厚度選擇，適合不同菜式需要。



薄蔥粒 大蔥粒

手動切蔥機 Manual Negihei

型號	Model		CB105007
尺寸	Dimensions	(mm)	400×230×360
重量	Weight	(kg)	3.9
厚度調整	Adjustment range	(mm)	1.0 / 1.5 / 2.0
附件	Attachment	(mm)	遮檔板手、替換刀片

機身輕巧，簡單易用，方便清潔。



大蔥絲 青蔥絲

手動蔥絲機(連芯) Manual Shiraga 2000 (Core type)

型號	Model		CB105019
尺寸	Dimensions	(mm)	195×240×285
重量	Weight	(kg)	2
切絲厚度	Size of green onion	(mm)	3
處理能力	Process ability		3 kg / 10 分鐘
連續使用時間	Usage time	(min)	10

附有十字刀片，簡單製造餃子餡料。



電動

電動餃子打餡機

型號	Model		KD051097
尺寸	Dimensions	(mm)	Ø152×363
重量	Weight	(kg)	3.0
功率	Power	(w)	120
電壓	Voltage	(V)	110

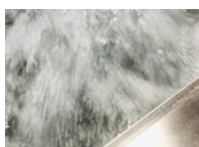

水循環沖洗



防止水灘出



防濺蓋擋板



清洗肉類血水 有效關除血腥味



凍肉解凍機 (啤水機) Defrosting Machine

型號 Model	尺寸 - 濶 × 深 × 高 Dimensions - W × D × H		功率 Power (w)	電壓 Voltage (V)	可解凍重量 Defrost weight (kg)	解凍時間 Defrost time (mins)
	(mm)	(in)				
TN-800	800 × 700 × (850+150)	31.5" × 28" × (33.5" × 6")	380	220	50 ~ 60	5 ~ 20
TN-1500	1500 × 750 × (850+150)	59" × 30" × (33.5" × 6")	380	220	50 ~ 60	5 ~ 20

- 功能 360 度無死角清洗、不鏽鋼材質
- 節省時間節省水費省人工省精力



清洗乾淨
沖洗力度大



全自動凍肉解凍機 (啤水機) Fully Automatic Defrosting Machine

型號 Model	尺寸 - 濶 × 深 × 高 Dimensions - Ø × H		容量 Capacity (L)	功率 Power (w)	電壓 Voltage (V)	可解凍重量 Defrost weight (kg)	解凍時間 Defrost time (mins)
	(mm)	(in)					
ZG019	Ø 560 × 1070	Ø 22" × 42"	86			18 ~ 36	30 ~ 50

MADE IN TAIWAN
台灣製造磨豆分渣機
Soybean Grinder, Separate

型號 Model		TS-832-1	TS-832-2	TS-832-3
尺寸 - 潤 × 深 × 高 Dimensions - W × D × H	(mm)	400 × 400 × 630	400 × 470 × 1030	500 × 560 × 1120
	(in)	16" × 16" × 25"	16" × 18.5" × 40.5"	20" × 22" × 44"
產能 Production per hour	(kg/hr)	10 ~ 25	30 ~ 45	50 ~ 80
磨石直徑 Diameter of the grinding stone	(mm)	特殊金鋼砂、Ø92	特殊金鋼砂、Ø100	特殊金鋼砂、Ø120
功率 Power	(w)	750	1,200	1,500



甘蔗汁機 Sugar Cane Juice Extractor

型號 Model		TS-907
尺寸 - 潤 × 深 × 高 Dimensions - W × D × H	(mm)	430 × 500 × 1020
	(in)	17" × 20" × 40"
功率 Power	(w)	220 / 380

絞肉機 Meat Mincer



型號 Model		MM-12	MM-22A
尺寸 - 潤 × 深 × 高 Dimensions - W × D × H	(mm)	380 × 210 × 405	410 × 220 × 410
	(in)	29" × 32" × 47"	29" × 32" × 47"
絞肉產量 Production per hour	(kg/h)	120	220
功率 Power	(w)	800	900
電壓 Voltage	(V)	220	220

產品不斷改良，如有更改，均以實物為準。
Products are subject to change due to enhancements and continuous development.



SEP-A250



SEP-A300C



SEP-F400

全自動切片機 Automatic Slicer

型號 Model	尺寸 - 潤 × 深 × 高 Dimensions - W × D × H	功率 Power	刀片直徑 Blade size		切割厚度 Slice thickness
	(mm)	(w)	(mm)	(in)	(mm)
SEP-A250	835 × 638 × 680	180	Ø250	Ø9.8"	0 ~ 12
SEP-A300C	855 × 650 × 684	180	Ø300	Ø11.8"	0 ~ 14
SEP-A350	1055 × 755 × 750	370	Ø350	Ø13.8"	0 ~ 14
SEP-F350C	1160 × 825 × 1440	750	Ø350	Ø13.8"	0 ~ 30
SEP-F350C1 (不銹鋼外裝)	1160 × 825 × 1440	750	Ø350	Ø13.8"	0 ~ 30
SEP-F400	1450 × 730 × 1520	750	Ø400	Ø15.8"	0 ~ 30



SL 195ES-6



MOD250



MOD300



FAFG253E



FAFG303E

切片機 Gravity Slicer

型號 Model	尺寸 - 潤 × 深 × 高 Dimensions - W × D × H	功率 Power	刀片直徑 Blade size		切割厚度 Slice thickness
	(mm)	(w)	(mm)	(in)	(mm)
SL195ES-6	390 × 360 × 320	200	Ø195	Ø8"	0 ~ 12
MOD250	470 × 280 × 380	120	Ø250	Ø10"	0 ~ 16
MOD300	530 × 330 × 460	250	Ø300	Ø12"	0 ~ 15
FAFG253E	490 × 430 × 400	185	Ø250	Ø9.8"	0 - 15
FAFG303E	500 × 480 × 440	260	Ø300	Ø11.8"	0 - 15



200



2000



J-210



J-310

鋸骨機 Band Saw

型號 Model	尺寸 - 潤 × 深 × 高 Dimensions - W × D × H (mm)	功率 Power (w)	鋸帶長度 Cutting height (mm)	最大切割厚度 Slice thickness (mm)	工作台尺寸 Working table (mm)
200	460 × 430 × 730	1,125	1520	185	330 × 330
2000	540 × 470 × 890	1,125	1830	210	395 × 375
J-210	520 × 470 × 820	650	1650	155	500 × 380
J-310	590 × 570 × 1040	1,100	2000	180	560 × 425

意大利科西圖奶昔機 Quamar (Italy) - Commercial Drink Mixer

型號 Model	T2 單頭奶昔機 1-Head Drink Mixer	T22 雙頭奶昔機 2-Head Drink Mixer	
尺寸 - 潤 × 深 × 高 Dimensions - W × D × H	(mm)	190 × 160 × 490	260 × 170 × 490
	(in)	7.5" × 6" × 19"	10" × 7" × 19"
速度 Speed	(rpm)	15,000	15,000
功率 Power	(w)	200	2 x 200
電壓 Voltage	(V)	220	220
附件 Accessories	1 個不銹鋼杯 1 Stainless steel cup	2 個不銹鋼杯 2 Stainless steel cups	



T2



T22

美國咸美頓奶昔機 Hamilton Beach (USA) - Commercial Drink Mixer

型號 Model	HMD200 高效能單頭奶昔機 Single Spindle Drink Mixer	HMD400 高效能三頭奶昔機 Heavy Duty Triple Spindle Drink Mixer	
尺寸 - 潤 × 深 × 高 Dimensions - W × D × H	(mm)	165 × 171 × 521	318 × 229 × 521
	(in)	6.5" × 7" × 20.5"	12.5" × 9" × 20.5"
功率 Power	(w)	600	900
電壓 Voltage	(V)	220	220
附件 Accessories	1 個不銹鋼杯 1 Stainless steel cup	3 個不銹鋼杯 3 Stainless steel cups	



HMD200



HMD400

美國皇庭牌攪拌機 Waring (USA) - Heavy Duty Food Blender

型號 Model	CB15E	
尺寸 - 潤 × 深 × 高 Dimensions - W × D × H	(mm)	260 × 260 × 650
	(in)	10" × 10" × 26"
容量 Capacity	(L)	4
功率 Power	(w)	1,600
電壓 Voltage	(V)	220
附件 Accessories	不銹鋼手柄容器 ; 橡膠蓋 Stainless steel container with two handles and easy-off rubberized lid	



CB15E



美國新奇士高效能榨汁機 Sunkist (USA) - Heavy Duty Juice Extractor

型號 Model	8	
尺寸 - 潤 × 深 × 高 Dimensions - W × D × H	(mm)	204 × 204 × 432
	(in)	8" × 8" × 17"
功率 Power	(w)	200
電壓 Voltage	(V)	220
規格 Specifications	配有重型馬達、獨特振動過濾器 and 可互換的壓榨內膽 Complete with heavy-duty motor, unique oscillating strainer & interchangeable extracting bulbs	



8

美國 KitchenAid 商用升降式廚師機 KitchenAid(USA) - Heavy Duty Bowl-Lift Stand Mixer

KitchenAid

型號 Model	5KPM5BER		5KPM5BWH	
	紅色 Red		白色 White	
尺寸 - 潤 × 深 × 高 Dimensions - W × D × H	(mm)	260 × 340 × 410		
	(in)	10" × 13" × 16"		
功率 Power	(w)	315		
可攪拌容量 Holding capacity	(L)	4.8		
附件 Accessories	不鏽鋼碗, 防濺罩, 打蛋器, 攪拌槳, 麵團鉤, 保護蓋 Stainless Steel Bowl, Transparent pouring shield, Wire Whip, Flat Beater, Dough Hook, Protection Cover			



5KPM5BWH

5KPM5BER



HC-S32A



HC-77B



HB-320A

Hatsuyuki

日本初雪牌刨雪粉機 Hatsuyuki (Japan)- Cube Ice Shaver

型號 Model	名稱 Description	尺寸 - 潤 × 深 × 高 Dimensions - W × D × H		時產量 Hry Production (kg)	冰斗 Ice hopper (pcs)	功率 Power (w)	有效刨雪粉尺寸 Effective Shaving (Ø mm)
		(mm)	(in)				
HC-S32A	高效能刨雪粉機 Cube Ice Shaver	306 × 402 × 429	12" × 16" × 17"	84	35	220	-
HC-77B	專業型高速刨雪粉機 Professional Type Cube Ice Shaver	290 × 360 × 499	11" × 14" × 20"	150	70 ~ 77	220	-
HB-320A	冰塊刨雪粉機 Cube Ice Shaver	355 × 402 × 760	14" × 16" × 30"	108	-	130	200



GSM700PSS0NUC1

Breville

Breville 煙燻槍 Breville - Smoking Gun

型號 Model	名稱 Description	尺寸 - 潤 × 深 × 高 Dimensions - W × D × H (mm)	材質 Material	規格 Specifications
GSM700PSS0NUC1	煙燻槍	450 × 145 × 450	430 不鏽鋼頭 430 Stainless Steel	無極調速, 需要 4 顆 AA 電池 Stepless speed regulation, 4 AA batteries required



FM3

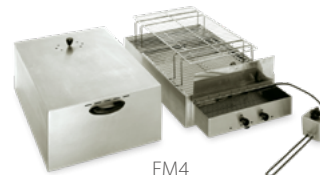

FM4

ROLLER GRILL



法國 Roller Grill 電三文魚煙燻爐 Roller Grill - Electric Salmon Smoker

型號 Model	名稱 Description	尺寸 - 潤 × 深 × 高 Dimensions - W × D × H (mm)		功率 Power (w)	附件 Accessories
		機身 body	烹飪格網 Cooking grid		
FM3	電三文魚單層煙燻爐	1000 × 410 × 200	800 × 400	250	附自動點火裝置、電熱絲和計時器 Complete with automatic ignition, heating element and time
FM4	電三文魚雙層煙燻爐	715 × 415 × 360	下層 Lower grid: 600 × 400 上層 Upper grid: 545 × 340	250	

產品不斷改良, 如有更改, 均以實物為準。
Products are subject to change due to enhancements and continuous development.



HBB908



HBB2505R



HBH450



HBF510S



HBH650



HBF1100S



HBH850

美國威美頓攪拌機 Hamilton Beach (USA) - Commercial Blender

型號 Model	名稱 Description	尺寸 - 潤 × 深 × 高 Dimensions - W × D × H		容量 Capacity (L)	功率 Power (w)	電壓 Voltage (V)	附件 Accessories
		(mm)	(in)				
HBB908		165 × 203 × 387	6.5" × 8" × 15"	1.25	400	220	聚碳酸酯容器; 蓋子 Polycarbonate container; lid
HBB2505	酒吧攪拌機 Bar Blender	165 × 203 × 393	6.5" × 8" × 15.5"	0.95	450	220	不銹鋼容器; 加註口的蓋子 SS container; lid with filler-cap
HBH450		165 × 229 × 432	6.5" × 9" × 17"	1.4	600	220	聚碳酸酯容器; 加料口的蓋子 Polycarbonate container; lid with filler cap
HBF510S	食物攪拌機 Culinary Blender	190 × 215 × 515	7.5" × 8.5" × 20"	1.8	1400	220	帶蓋不銹鋼容器; 開蓋感測器 SS container with lid and open sensor
HBH650	沙冰攪拌機 Tempest Blender	178 × 203 × 457	7" × 8" × 18"	1.8	880	220	聚碳酸酯容器; 加料口的蓋子 Polycarbonate container; lid with filler cap
HBF1100S	食物攪拌機 Heavy Duty Food Blender	226 × 378 × 481	9" × 15" × 19"	4	1500	220	不銹鋼手柄容器; 透明蓋帶鎖劑量杯 SS container with 2 handles; transparent lid with locks and dosing cup
HBH850	靜音罩高效能 酒吧攪拌機 Quiet Shield Summit Blender	229 × 305 × 483	9" × 12" × 19"	1.8	880	220	聚碳酸酯容器; 加料口的蓋子; 靜音罩 Polycarbonate container; lid with filler cap;

■ 玻璃容器
Glass Container

Panasonic 樂聲牌

日本樂聲牌攪拌機 Panasonic (Japan) - Commercial Blender

型號 Model	尺寸 - 潤 × 深 × 高 Dimensions - W × D × H		功率 Power (w)	可攪拌容量 Holding capacity (L)
	(mm)	(in)		
MX-EX1011	173 × 161 × 353	7" × 6" × 14"	400	1
MX-EX1511	189 × 174 × 414	7" × 7" × 16"	450	1.5
MX-EX1561	179 × 236 × 425	7" × 9" × 17"	450	1.5



MX-EX1011



MX-EX1511



MX-EX1561

日本樂聲牌手提式打蛋器 Panasonic (Japan) - Hand Mixer

型號 Model	MK-GH3	
尺寸 - 潤 × 深 × 高 Dimensions - W × D × H	(mm)	93 × 19.5 × 151
	(in)	4" × 1" × 6"
功率 Power	(w)	175
附件 Accessories	打蛋棒, 攪麵糰鉤 Egg beaters and dough hooks	



MK-GH3



MADE IN TAIWAN
台灣製造

蛋糕烘焙 麵糰攪拌好幫手



蛋糕

中式包點

製麵

PIZZA

麵包

餅乾



TS-201



TS-208



TS-240



TS-30C 雙葉攪拌機

配件 ACCESSORIES



勾 HOOK



球 TINISO WHISK



扇 BEATER



TS-518



TS-568 螺旋攪拌機

全部攪粉機均會配有安全保護罩
ALL MIXERS ARE EQUIPPED WITH A SAFETY COVER

攪粉機 Mixer

型號 Model	尺寸 - 闊 × 深 × 高 Dimensions - W × D × H		功率 Power (w)	轉速 Motor speed (rpm)	可攪拌容量 Holding capacity (L)	麵團承載量 Flour Capacity (kg)
	(mm)	(in)				
TS-201	520 × 480 × 810	20.5" × 20" × 32"	380	110 / 225 / 475	20	3
TS-208	640 × 600 × 1010	25.5" × 24" × 40"	750	80 / 168 / 310	30	6
TS-240	560 × 590 × 1060	22" × 23.5" × 42"	1,120	80 / 166 / 316	40	9
TS-518	690 × 690 × 1070	27.5" × 27.5" × 42.5"	1,500	90 / 200 / 400	50	12
TS-568 (螺旋)	1200 × 720 × 1170	47.5" × 28.5" × 46"	3,560	-	130	50
TS-30C (雙葉)	550 × 510 × 1260	22" × 20" × 50"	380	-	30	10 ~ 15

台灣食品機械系列
TAIWANESE FOOD MACHINERY

MADE IN TAIWAN
台灣製造

TS-813

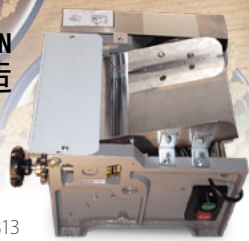

TS-801



TS-802



壓麵機 Dough Press, Noodle Maker

型號 Model		尺寸 - 潤 × 深 × 高 Dimensions - W × D × H		功率 Power (w)	輸送帶 Conveyor (mm)	機輪 Roller (mm)
		(mm)	(in)			
TS-813A	桌上型壓麵機	380 × 390 × 360	15" × 15.5" × 14.5"	380	-	-
TS-813B		380 × 480 × 360	15" × 19" × 14.5"	560	-	-
TS-801-1	桌上型 丹麥壓麵機	1800 × 760 × 600	71" × 30" × 24"	380	430 × 1700	88 × 435
TS-801-2		1800 × 850 × 600	71" × 33.5" × 24"	380	515 × 1700	88 × 520
TS-802-1	落地型 丹麥壓麵機	2100 × 760 × 1100	83" × 30" × 43.5"	380	430 × 2000	88 × 435
TS-802-2		2100 × 850 × 1100	83" × 33.5" × 43.5"	380	515 × 2000	88 × 520
TS-802-3		2500 × 960 × 1100	98.5" × 38" × 43.5"	750	630 × 2400	88 × 635
TS-802-2C		2500 × 850 × 1100	98.5" × 33.5" × 43.5"	750	515 × 2400	88 × 520
TS-802-3C		3000 × 960 × 1100	118.5" × 38" × 43.5"	750	630 × 2900	88 × 635

TS-803



TS-804



長型多士整型機 Dough Moulder

型號 Model		尺寸 - 潤 × 深 × 高 Dimensions - W × D × H		功率 Power (w)	輸送帶 Conveyor (mm)	機輪 Roller (mm)
		(mm)	(in)			
TS-803-1		1210 × 580 × 1050	48" × 23" × 41.5"	380	290 × 1960	90 × 300
TS-803-2		1360 × 580 × 1100	53.5" × 23" × 43.5"	380	290 × 2280	90 × 300
TS-803-3		1360 × 680 × 1100	53.5" × 27" × 43.5"	750	380 × 2280	90 × 390
TS-804-1(兩組機輪)		1200 × 600 × 1080	47" × 24" × 42.5"	380	350 × 2200	76 × 290
TS-804-2(可整型法國麵包)		1200 × 700 × 1080	47" × 27.5" × 42.5"	750	430 × 2200	76 × 390

手動分塊機 Dough Divider

型號 Model	TS-805	
分塊範圍 Dividing Range (g)	30 ~ 100	
分塊範圍 Dividing Pcs (pcs)	36	
尺寸 - 潤 × 深 × 高 Dimensions - W × D × H	(mm)	380 × 500 × 610
	(in)	15" × 20" × 24"



中型吐司切片機 Bread Slicer

型號 Model	TS-202	
刀距 Blade distanc (mm)	12	
尺寸 - 潤 × 深 × 高 Dimensions - W × D × H	(mm)	680 × 630 × 730
	(in)	27" × 25" × 29"
功率 Power (w)	200	



產品不斷改良，如有更改，均以實物為準。
Products are subject to change due to enhancements and continuous development.

MADE IN TAIWAN
台灣製造



桌上型不銹鋼製麵條機
Stainless Steel Dough Press

型號 Model		TS-815
尺寸 - 潤 × 深 × 高 Dimensions - W × D × H	(mm)	520 × 440 × 510
	(in)	20" × 17" × 20"
功率 Power	(w)	186

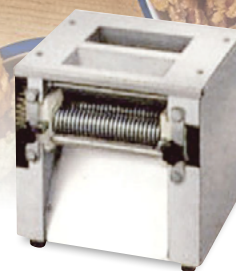

輕巧型製麵條機
Noodles Making Machine

型號 Model		TS-814
尺寸 - 潤 × 深 × 高 Dimensions - W × D × H	(mm)	230 × 270 × 260
	(in)	9" × 10.5" × 10"
功率 Power	(w)	250



切菜機
Vegetable Cutter

型號 Model		TS-508-1
尺寸 - 潤 × 深 × 高 Dimensions - W × D × H	(mm)	420 × 330 × 740
	(in)	16.5" × 13" × 29"
功率 Power	(w)	375



皮帶式切蔥機
Shallot Cutter

型號 Model		TS-302
尺寸 - 潤 × 深 × 高 Dimensions - W × D × H	(mm)	420 × 350 × 430
	(in)	16.5" × 13.8" × 16.9"
功率 Power	(w)	刀: 40 / 輸送帶: 30



10 斤分離式脫漿機
Liquid Extracting

型號 Model		TS-811 分離式脫漿機	TS-810	MH-819A
尺寸 - 直徑 × 高 Dimensions - Dia. × H	(mm)	∅390 × 900	∅450 × 830	500 × 400 × 830
	(in)	∅15.5" × 35.5"	∅18" × 33"	20" × 16" × 33"
功率 Power	(w)	375	375	375



磨豆米機
Soybean Grinder

型號 Model		
產能 Production per hour	(kg/hr)	
磨石直徑 Diameter of the grinding stone	(mm)	
尺寸 - 潤 × 深 × 高 Dimensions - W × D × H	(mm)	
	(in)	
功率 Power	(w)	



型號 Model	TS-831-1D
產能 Production per hour	20~30
磨石直徑 Diameter of the grinding stone	∅ 125 特殊金鋼砂
尺寸 - 潤 × 深 × 高 Dimensions - W × D × H	450 × 260 × 1050 18" × 10" × 41"
功率 Power	375



型號 Model	TS-831-2D
產能 Production per hour	30~50
磨石直徑 Diameter of the grinding stone	∅ 150 特殊金鋼砂
尺寸 - 潤 × 深 × 高 Dimensions - W × D × H	450 × 260 × 1080 18" × 10" × 43"
功率 Power	750

產品不斷改良，如有更改，均以實物為準。
Products are subject to change due to enhancements and continuous development.

MADE IN TAIWAN
台灣製造

小太陽

小太陽
食物處理器
Food Blender

食物處理機



冰沙處理機



冰沙處理機

型號 Model		TX-180	TM-767	TM-737
尺寸 - 潤 × 深 × 高 Dimensions - W × D × H	(mm)	200 × 270 × 390	205 × 230 × 490	205 × 230 × 430
	(in)	8" × 10.5" × 15.5"	8" × 9" × 19.5"	8" × 9" × 17"
容器容量 Cup capacity	(L)	2	2	1.5
轉速 Motor speed	(rpm)	20000	22000~32000	22000~32000
功率 Power	(w)	180	850	850
電壓 Voltage	(V)	220	220	220



RT-02



RT-04



RT-08

粉碎機
Grinding Machine

型號 Model		RT-02	RT-04	RT-08
粉碎槽尺寸 - 直徑 × 高 Grinding trough size - Dia. × H	(mm)	Ø114 × 87	Ø139 × 95	Ø174 × 124
尺寸 - 潤 × 深 × 高 Dimensions - W × D × H	(mm)	172 × 136 × 285	207 × 195 × 325	255 × 195 × 403
	(in)	7" × 5.5" × 11"	8" × 7.5" × 12.8"	10" × 7.5" × 15.9"
功率 Power	(w)	820	1,200	1,800
轉速 Speed	(rpm)	28,000	25,000	22,000



RT-12



RT-34



RT-20

粉碎機
Grinding Machine

型號 Model		RT-12	RT-34	RT-20
粉碎槽尺寸 - 直徑 × 高 Grinding trough size - Dia. × H	(mm)	Ø174 × 132	Ø175 × 80	Ø230 × 110
尺寸 - 潤 × 深 × 高 Dimensions - W × D × H	(mm)	255 × 190 × 413	500 × 300 × 540	650 × 450 × 930
	(in)	10" × 7.5" × 16.3"	19.5" × 12" × 21.5"	25.5" × 18" × 36.6"
功率 Power	(w)	1,900	750	1,500
轉速 Speed	(rpm)	26,000	3,450	3,450

產品不斷改良，如有更改，均以實物為準。
Products are subject to change due to enhancements and continuous development.

中華座地 穿梭機



QRTS-200



QRTS-100

絞肉機 / 切肉機 Mincer / Cutter

型號 Model		QRTS-200 中華座地穿梭機	QRTS-100 座枱切肉機
刀距 Blade distance	(mm)	3	3
尺寸 - 闊 × 深 × 高 Dimensions - W × D × H	(mm)	460 × 585 × 890	330 × 460 × 435
	(in)	18" × 23" × 35"	13" × 18" × 17"
功率 Power	(w)	750	550
電壓 Voltage	(V)	220 / 380	220



B10 攪粉機



B20 攪粉機



B30FA

攪粉機 Mixer

型號 Model	尺寸 - 闊 × 深 × 高 Dimensions - W × D × H		功率 Power	轉速 Motor speed	可攪拌容量 Holding capacity	麵團承載量 Flour Capacity
	(mm)	(in)				
B10	355 × 430 × 560	14" × 17" × 22"	600	480 / 244 / 148	10	1.5
B20	560 × 510 × 815	22" × 20" × 32"	1,100	508 / 258 / 156	20	3
B30FA	600 × 640 × 1080	24" × 25" × 42.5"	1,300	430 / 204 / 125	30	7



SL003-1P



SL003-2P



SL003-3P

凍飲機
Cold Drink Dispenser

型號 Model	尺寸 - 潤 × 深 × 高 Dimensions - W × D × H (mm)	冷藏溫度 Refrigerating Temperature (°C)	功率 Power (w)	容量 Capacity (L)
SL003-1P	280 × 470 × 690	8~10	200	12
SL003-2P	410 × 470 × 690	8~10	350	2 × 12
SL003-3P	610 × 470 × 690	8~10	370	3 × 12
LP30B-W	535 × 520 × 808	-	705	30
LJ30 (攪拌式)	535 × 520 × 808	-	705	30



LP30B-W



LJ30

意大利凍飲機
Italian Cold Drink Dispenser



COF 1M



COF 2M



COF 3M



COF 4M

型號 Model	尺寸 - 潤 × 深 × 高 Dimensions - W × D × H (mm)	功率 Power (w)	容量 Capacity (L)
COF 1M	200 × 440 × 675	150	12
COF 2M	400 × 440 × 675	230	2 × 12
COF 3M	600 × 440 × 675	420	3 × 12
COF 4M	800 × 440 × 675	230 × 2	4 × 12



聯品章魚丸爐 Luen Pun Takoyaki



型號 Model		MQ1	MQ2	MQ3
尺寸 - 濶 × 深 × 高 Dimensions - W × D × H	(mm)	230 × 370 × 220	455 × 370 × 220	680 × 370 × 220
	(in)	9" × 14.5" × 9"	18" × 14.5" × 9"	27" × 14.5" × 9"
功率 Power	(w)	1,500	1,500 × 2	1,500 × 3
電壓 Voltage	(V)	220	220	220



聯品 - 香港傳統餅爐 Luen Pun Crepe Machine

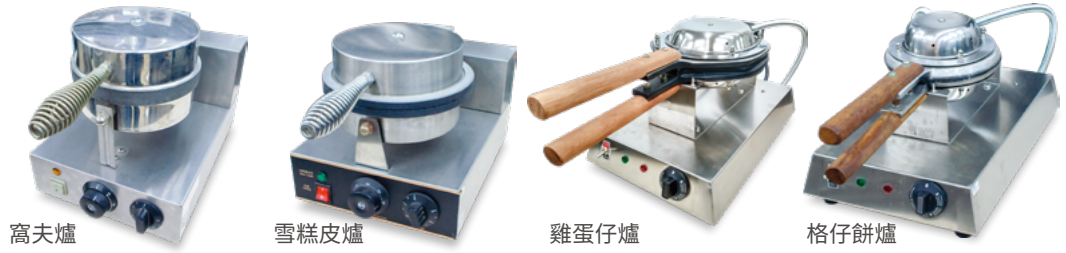

型號 Model		DZ5	DE5	DZ1	DZ3
尺寸 - 濶 × 深 × 高 Dimensions - W × D × H	(mm)	300 × 250 × 380	250 × 480 × 250	270 × 413 × 230	270 × 413 × 230
	(in)	12" × 10" × 15"	10" × 19" × 10"	11" × 16" × 9"	11" × 16" × 9"
功率 Power	(w)	1,100	1,100	1,100	1,100
電壓 Voltage	(V)	220	220	220	220



法國 Roller Grill 班戟爐 Roller Grill Crepe Machine



型號 Model		CFE 400	CVE 400	CSE 350 / CSE 400	CDE 350 / CDE 400
尺寸 - 濶 × 深 × 高 Dimensions - W × D × H	(mm)	400 × 190	450 × 480 × 210	450 × 480 × 240	860 × 480 × 240
	(in)	16" × 7.5"	18" × 19" × 8"	18" × 19" × 9.5"	34" × 19" × 9.5"
功率 Power	(w)	3,600	2,500	3,000 / 3,600	2 × 3,000 / 2 × 3,600
電壓 Voltage	(V)	230	230	230	380 / 230



法國 Roller Grill 窩夫爐 Roller Grill Waffle Maker



型號 Model	單頭	GES 10	GES 20	GES 23	GES 40	GES 75	GES 80
	雙頭	GED 10	GED 20	-	GED 40	GED 75	GED 80
尺寸 - 濶 × 深 × 高 Dimensions - W × D × H	(mm)	305 × 510 × 310	305 × 510 × 310	305 × 510 × 310	305 × 510 × 310	305 × 510 × 310	305 × 510 × 310
	(in)	12" × 20" × 12"	12" × 20" × 12"	12" × 20" × 12"	12" × 20" × 12"	12" × 17.5" × 9"	12" × 20" × 12"
功率 Power	(w)	1,600 3,200	1,600 3,200	1,600	1,600 3,200	1,600 3,200	1,600 3,200
電壓 Voltage	(V)	230	230	230	230	230	230

另有更多 Roller Grill 烤爐，請參閱第 118 頁的「窩夫爐 Waffle Iron」。
For more Roller Grill Products, please see “窩夫爐 Waffle Iron” on page 118

產品不斷改良，如有更改，均以實物為準。
Products are subject to change due to enhancements and continuous development.

新增邊位焊接加工
雙重防漏、防菌衛生

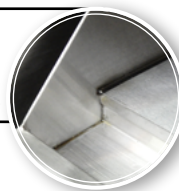

H004-PM16



H004-PM24



H004-PM30



聯品平面電熱扒爐 Luen Pun Electric Griddle

型號 Model		H004-PM10	H004-PM16	H004-PM21	H004-PM24	H004-PM30
尺寸 - 濶 × 深 × 高 Dimensions - W × D × H	(mm)	254 × 420 × 280	410 × 495 × 280	550 × 460 × 280	610 × 495 × 280	765 × 495 × 280
	(in)	10" × 16.5" × 11"	15.75" × 19.5" × 11"	21.5" × 19.5" × 11"	24" × 20" × 11"	30" × 50" × 11"
功率 Power	(w)	3,000	3,000	3,000	2 × 3,000	3 × 3,000



FY-818



FY-820



FY-821



FY-822

經濟型電熱扒爐 Economical Electric Griddle

型號 Model		FY-818	FY-820	FY-821	FY-822
尺寸 - 濶 × 深 × 高 Dimensions - W × D × H	(mm)	540 × 450 × 220	730 × 520 × 230	540 × 450 × 220	730 × 520 × 230
	(in)	21" × 18" × 7"	29" × 20" × 9"	21" × 18" × 7"	29" × 20" × 9"
功率 Power	(w)	3,000	4,400	3,000	4,400



BQ1/ BQ2 /BQ3



半平坑扒爐
BQB4/ BQB5 /BQB6 / BQB7



BQ8/ BQ9 /BQ12

平面 / 坑紋電熱扒爐 Electric Griddle

型號 Model		BQ1 36" 平扒爐	BQ2 32" 平扒爐	BQ3 30" 平扒爐	BQB4 28" 半平坑扒爐	BQB5 26" 半平坑扒爐
尺寸 - 濶 × 深 × 高 Dimensions - W × D × H	(mm)	915 × 525 × 300	810 × 525 × 300	760 × 525 × 300	710 × 525 × 285	645 × 525 × 285
	(in)	36" × 21" × 12"	32" × 21" × 12"	30" × 21" × 12"	28" × 21" × 11"	25" × 21" × 11"
功率 Power	(w)	3,000 × 3	3,000 × 3	2,500 × 3	3,000 × 2	3,000 × 2

型號 Model		BQB6 24" 半平坑扒爐	BQB7 22" 半平坑扒爐	BQ8 平扒爐	BQ9 平扒爐	BQ12 平扒爐
尺寸 - 濶 × 深 × 高 Dimensions - W × D × H	(mm)	610 × 457 × 250	560 × 490 × 250	525 × 425 × 250	455 × 425 × 250	406 × 460 × 250
	(in)	24" × 18" × 10"	22" × 19" × 10"	21" × 17" × 10"	18" × 17" × 10"	16" × 18" × 10"
功率 Power	(w)	2,500 × 2	2,000 × 2	3,000	3,000	2,500



MG-18



LG-18K



LG-24K



LG-36KN

利高牌座枱 LEEEO - Electric Griddle

型號 Model		MG-18 (Mini)	LG-18K (Flat Griddle)	LG-24K (Flat Griddle)	LG-36KN (1/3 Grooved+ 2/3 flat)
尺寸 - 濶 × 深 × 高 Dimensions - W × D × H	(mm)	460 × 460 × 280	450 × 700 × 360	600 × 700 × 360	900 × 700 × 360
功率 Power	(w)	2,850	6,000	9,000	15,000
電壓 Voltage	(V)	220	220	380	380

產品不斷改良，如有更改，均以實物為準。
Products are subject to change due to enhancements and continuous development.



MEF-M8T-SP



MEF-M8FT-SP



MEF-3TAE-SP

MEF-5TAE-SP
MEF-5TE-SP

MEF-8TE-SP



MEF-10TE-SP



MEF-10TPD-SP



MEF-10TPWD-SP



MEF-13E-SP



MEF-18E-SP



MEF-23E-SP/MEF-27E-SP



MEF-13WE-SP



MEF-23WE-SP



MEF-13FE-SP

日本丸善電熱炸爐 Maruzen Electric Fryer

	型號 Model	尺寸 - 潤 × 深 × 高 Dimensions - W × D × H (mm)	油量 Oil amount (L)	消耗功率 Power consumption (w)	功率 Power
迷你炸爐 Mini Fryer	MEF-M8T-SP	255 × 475 × 195	8	1,300	
	MEF-M8FT-SP	255 × 475 × 195	8	1,300	
桌上型款 Tabletop Type	MEF-3TAE-SP	220 × 400 × 200	3	1,300	
	MEF-5TAE-SP	300 × 420 × 200	5	1,800	
	MEF-5TE-SP	300 × 420 × 200	5	1,800	1/ 220-240V / 50Hz
	MEF-8TE-SP	300 × 470 × 250	8	3,400	
	MEF-10TE-SP	330 × 500 × 250	10	4,500	
	MEF-10TPD-SP	315 × 600 × 260	10	3,000	
桌上型快餐款 Tabletop Fast Food Type	MEF-10TPWD-SP	620 × 600 × 260	10 × 2	6,000	
	MEF-13E-SP	350 × 600 × 800	13	4,800	
常規款 Regular Type	MEF-18E-SP	450 × 600 × 800	18	6,400	
	MEF-23E-SP	550 × 600 × 800	23	8,000	
	MEF-27E-SP	620 × 600 × 800	27	10,000	
	MEF-13WE-SP	700 × 600 × 800	13 × 2	9,600	3/ 380-415V / 50Hz
	MEF-18WE-SP	900 × 600 × 800	18 × 2	12,800	
	MEF-23WE-SP	1100 × 600 × 800	23 × 2	16,000	
	MEF-13FE-SP	350 × 600 × 800	18	4,800	
快餐款 Fast Food Type	MEF-13FE-SP	350 × 600 × 800	18	4,800	



聯品電熱炸爐
Luen Pun Electric Fryer



H003-2/3DM8



H003-1/2DM8



H003-2/3DM10



H003-1/2MM8

型號 Model	H003-1/2DM8	H003-2/3DM8	H003-2/3DM10	H003-1/2MM8
尺寸 - 濶 × 深 × 高 Dimensions - W × D × H (mm)	280 × 435 × 245	365 × 435 × 365	370 × 460 × 365	560 × 445 × 245
(in)	11" × 17" × 10"	14" × 17" × 14.5"	14.5" × 18" × 14.5"	22" × 17.5" × 10"
功率 Power (w)	3,000	2,000 × 2	2,500 × 2	3,000 × 2
電壓 Voltage (V)	220	220	220	220



聯品經濟型電熱炸爐
Luen Pun Economical Electric Fryer



FY-80



FY-88



FY-89



WF-081

型號 Model	FY-80	FY-88	FY-89	WF-081
尺寸 - 濶 × 深 × 高 Dimensions - W × D × H (mm)	200 × 450 × 310	285 × 455 × 360	570 × 450 × 360	190 × 440 × 320
(in)	8" × 17.5" × 7.5"	11" × 18" × 14"	22" × 18" × 14"	7.5" × 17.5" × 12.5"
功率 Power (w)	2,000	2,800	2,800 × 2	2,000
電壓 Voltage (V)	220	220	220	220



利高牌高效電熱炸爐
LEEKO - Electric Countertop Fryer



MF-11



MF-22



LF-15K



LF-30K

型號 Model	MF-11 小型單缸	MF-22 小型雙缸	LF-15K 單缸	LF-30K 雙缸
尺寸 - 濶 × 深 × 高 Dimensions - W × D × H (mm)	275 × 460 × 315	552 × 460 × 315	350 × 700 × 360	650 × 700 × 360
炸籃尺寸 basket size (mm)	190 × 230 × 100	190 × 230 × 100	210 × 300 × 130	210 × 300 × 130
油箱容量 Oil Tank Volume (L)	7	7 × 2	9	9 × 2
功率 Power (w)	2,850	2,850 × 2	6,000	6,000 × 2
電壓 Voltage (V)	220	220	220	220



利高牌高效電熱炸爐
LEEKO - Electric Countertop Fryer



LF-15KL / LF-15HL



LF-15H



LF-30H



TF-1

型號 Model	LF-15KL / LF-15HL 單缸升降 (程控式)	LF-15H 單缸 (程控式)	LF-30H 雙缸 (程控式)	TF-1 座檯天婦羅炸爐
尺寸 - 濶 × 深 × 高 Dimensions - W × D × H (mm)	350 × 700 × 360	350 × 700 × 360	650 × 700 × 360	500 × 700 × 300
炸籃尺寸 basket size (mm)	210 × 300 × 130	210 × 300 × 130	210 × 300 × 130	油盆 Oil Pan: Ø440 × 100
油箱容量 Oil Tank Volume (L)	9	9	9 × 2	
功率 Power (w)	6,000	9,000	9,000 × 2	4,000
電壓 Voltage (V)	380	380	380	380



電面火爐 Electric Salamander

型號 Model	AT-936	AT-937	AT-938	EB-450 (升降式)	EB-600 (升降式)	EB-800 (升降式)
尺寸 - 濶 × 深 × 高 Dimensions - W × D × H (mm)	570 × 340 × 260	800 × 450 × 470	580 × 390 × 390	450 × 450 × 500	600 × 450 × 500	800 × 450 × 500
升降行程 Up & down travel (mm)	-	-	-	0 ~ 140	0 ~ 140	0 ~ 140
溫度範圍 Temperature (°C)	-	-	-	50 ~ 300	50 ~ 300	50 ~ 300
功率 Power (w)	2,000	4,000	2,200	2800	4,000	5,600
電壓 Voltage (V)	220	220	220	220	220	220



TT-150 / TT-300 / TT-450

鏈式多士爐 Electric Conveyor Toaster

型號 Model	TT-150	TT-300	TT-450
尺寸 - 濶 × 深 × 高 Dimensions - W × D × H (mm)	288 × 418 × 387	368 × 418 × 387	468 × 418 × 387
功率 Power (w)	1,340	2,240	2,640
電壓 Voltage (V)	220	220	220



QCS1-350



AT EXPRESS

鏈式多士爐 Electric Conveyor Toaster

型號 Model	QCS1-350	AT EXPRESS
尺寸 - 濶 × 深 × 高 Dimensions - W × D × H (mm)	362 × 479 × 337	375 × 457 × 337
功率 Power (w)	1,600	1,725
電壓 Voltage (V)	220	220



勞耐 - 多士爐

Rowlett Rutland - Toaster



型號 Model	4TTS-151 2厚2薄多士爐	4ATS-254 4片薄多士爐	6ATS-261 6片薄多士爐
尺寸 - 潤 × 深 × 高 Dimensions - W × D × H (mm)	390 × 210 × 225	370 × 210 × 225	460 × 210 × 225
功率 Power (w)	1,800	2,300	3,300
電壓 Voltage (V)	220	220	220

SILK-ROAD®

施樂 - 多士爐

SILK-ROAD - Toaster



型號 Model	SR-428 4片不銹鋼多士爐	SR-228 2片不銹鋼多士爐
尺寸 - 潤 × 深 × 高 Dimensions - W × D × H (mm)	280 × 250 × 210	180 × 160 × 200
功率 Power (w)	1,800	1,050
電壓 Voltage (V)	220	220



德國卓爾 - 多士爐

SUMME - Toaster



型號 Model	BT-S808 2片不銹鋼多士爐	BT-S408 4片不銹鋼多士爐
尺寸 - 潤 × 深 × 高 Dimensions - W × D × H (mm)	152 × 280 × 185	283 × 280 × 185
功率 Power (w)	860~1050	1820~2100
電壓 Voltage (V)	220-240	220-240



聯品串燒爐 Luen Pun Skewer Furnace



- 可依食材種類調整溫度，達到最佳效果
- 火管加熱快、溫度集中、耗時短
- 兩組調溫器，燒烤面積大，亦可作保溫用

■ 可調較高低角度

型號 Model	ZB-8	日式串燒爐 H-609	H023-SBQ23
尺寸 - 濶 × 深 × 高 Dimensions - W × D × H (mm)	735 × 330 × 140	940 × 330 × 305	584 × 280 × 178
(in)	29" × 13" × 5.5"	37" × 13" × 12"	23" × 11" × 7"
功率 Power (w)	3,000 × 2	3,000 × 3	3,000
電壓 Voltage (V)	220	220	220



聯品串燒爐 Luen Pun Skewer Furnace

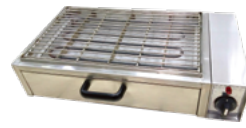
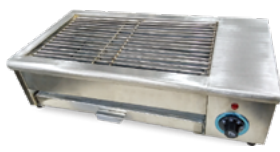

型號 Model	H023-SBQ24	H023-SBQ22	ZB-2	ZB-3
尺寸 - 濶 × 深 × 高 Dimensions - W × D × H (mm)	610 × 330 × 178	559 × 457 × 203	587 × 330 × 140	660 × 330 × 140
(in)	24" × 13" × 7"	22" × 18" × 8"	23" × 13" × 5.5"	26" × 13" × 5.5"
功率 Power (w)	3,000	3,000 × 2	3,000	2,000 × 2
電壓 Voltage (V)	220	220	220	220



聯品串燒爐 Luen Pun Skewer Furnace



型號 Model	ZB-5	ZB-7	ZB-15	Q24-1
尺寸 - 濶 × 深 × 高 Dimensions - W × D × H (mm)	712 × 200 × 140	560 × 390 × 203	1000 × 460 × 260	610 × 230 × 165
(in)	28" × 8" × 5.5"	22" × 15" × 8"	39" × 18" × 10"	24" × 9" × 6.5"
功率 Power (w)	3,000	2,000 × 2	3,000 × 3	2,000
電壓 Voltage (V)	220	220	220	220



喜高牌日式電燒烤爐 Higo Griller - Electric Griller



型號 Model	3P-206KC	3P-212C	3H-215YC
尺寸 - 濶 × 深 × 高 Dimensions - W × D × H (mm)	760 × 410 × 390	810 × 550 × 380	890 × 550 × 450
(in)	30" × 16" × 15"	32" × 22" × 15"	35" × 22" × 18"
功率 Power (w)	6,000	12,000	15,000
電壓 Voltage (V)	380	380	380

產品不斷改良，如有更改，均以實物為準。
Products are subject to change due to enhancements and continuous development.



GN 1/2



GN 1/4



GN 1/3



GN 1/6

聯品不銹鋼電熱汁箱

Luen Pun - Bain Marie

型號 Model	SM21.513	SM17.5	SM29	SM21.5
尺寸 闊 × 深 × 高 Dimensions W × D × H	(mm) 550 × 335 × 305	445 × 335 × 305	740 × 335 × 305	550 × 500 × 305
	(in) 21.5" × 13" × 12"	17.5" × 13" × 12"	29" × 13" × 12"	21.5" × 19.5" × 12"
功率 Power	(w) 2,000	2,000	2,000	3,000
可配份數盆 Gastronorm Containers				

型號 Model	SM13.2	SM19.6	SM13.5	SM19.64	SM14.5
尺寸 闊 × 深 × 高 Dimensions W × D × H	(mm) 340 × 195 × 305	500 × 195 × 305	345 × 270 × 305	500 × 270 × 305	370 × 335 × 305
	(in) 13.2" × 7.5" × 12"	19.6" × 7.5" × 12"	13.5" × 10.6" × 12"	19.6" × 10.6" × 12"	14.5" × 13" × 12"
功率 Power	(w) 1,000	1,000	1,000	2,000	2,000
可配份數盆 Gastronorm Containers					

聯品不銹鋼平底電熱汁箱 (連放水掣)

Luen Pun - Bain Marie With Tap

型號 Model	SM21.513T
尺寸 闊 × 深 × 高 Dimensions W × D × H	(mm) 550 × 400 × 300
	(in) 21.5" × 16" × 12"
功率 Power	(w) 2,000

* 可配份數盆 (同上) Gastronorm Containers (Same as above)



聯品港式叉燒

Luen Pun - Hong Kong-style Bain Marie

型號 Model	LM15	LM19	LM20
尺寸 闊 × 深 × 高 Dimensions W × D × H	(mm) 380 × 280 × 305	485 × 355 × 330	510 × 300 × 360
	(in) 15" × 11" × 12"	19" × 14" × 13"	20" × 12" × 14"
功率 Power	(w) 1,000	1,000	1,000



產品不斷改良，如有更改，均以實物為準。
Products are subject to change due to enhancements and continuous development.



櫃式燒臘電烤爐 Siu Mei (Roasted Meat) Cabinet

型號 Model	CGP-600	
尺寸 - 濶 × 深 × 高 Dimensions - W × D × H	外 External (mm)	1100 × 830 × 1630
	內 Chamber (mm)	610 × 610 × 820
溫度範圍 Temperature	(°C)	60 ~ 350
功率 Power	(w)	12,000
電壓 Voltage	(V)	380
烤製時間 Baking time	(min)	18
有效容積 Validity Capacity	可放 6 隻鵝 ; 8 隻鴨 ; 4 隻乳豬 ; 10 隻雞 ; 18 斤叉燒 Accommodate 6 geese ; 8 ducks ; 4 suckling pig ; 10 chickens ; 18 pounds of barbecued pork	



CGP-600

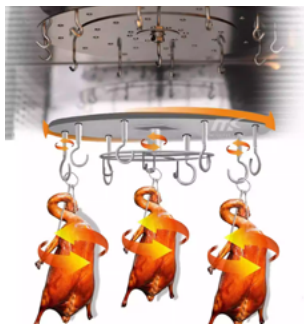

360° 自旋轉掛盤

- 耐用承重掛盤、耐高溫
- 每一面都可平均燒到



CGP-100



CGP-140

燒臘電烤爐 Siu Mei (Roasted Meat) Oven

型號 Model	CGP-100		CGP-140		
尺寸 - 濶 × 深 × 高 Dimensions - W × D × H	外 External (mm)	900 × 580 × 1100	內 Chamber (mm)	1040 × 720 × 1050	
	內 Chamber (mm)	420 × 380 × 820	外 External (mm)	530 × 500 × 820	
溫度範圍 Temperature	(°C)	60 ~ 350	溫度範圍 Temperature	(°C)	60 ~ 350
功率 Power	(w)	7,000	功率 Power	(w)	11,000
電壓 Voltage	(V)	220/380	電壓 Voltage	(V)	380
烤製時間 Baking time	(min)	18	烤製時間 Baking time	(min)	18
有效容積 Validity Capacity	可放 2 隻鵝 ; 4 隻鴨 ; 1 隻乳豬 ; 6 隻雞 ; 7 斤叉燒 Accommodate 2 geese ; 4 ducks ; 1 suckling pig ; 6 chickens ; 7 pounds of barbecued pork		可放 4 隻鵝 ; 6 隻鴨 ; 3 隻乳豬 ; 8 隻雞 ; 14 斤叉燒 Accommodate 4 geese ; 6 ducks ; 3 suckling pig ; 8 chickens ; 14 pounds of barbecued pork		

電動雙層燒豬爐 Pig Roaster

型號 Model	A-3340	
尺寸 - 濶 × 深 × 高 Dimensions - W × D × H	(Ø in) (Ømm)	Ø40" × 82" Ø1020 × 2080
功率 Power	(w)	20,000
電壓 Voltage	(V)	380

燒豬爐可擺放在水吧位或燒鹵櫃位 ;
可保持溫度，即燒即食
The roaster can maintain temperature, ready to cook and eat



A-3340

產品不斷改良，如有更改，均以實物為準。
Products are subject to change due to enhancements and continuous development.

- 紅色 RED
- 黑色 BLACK



弧形保溫櫃 Food Display Warmer

型號 Model	601 / R60-2	602 / R60-1	603 / R60-3
尺寸 - 濶 × 深 × 高 Dimensions - W × D × H (mm)	660 × 437 × 635	900 × 480 × 590	1200 × 480 × 810
溫度範圍 Temperature (°C)	30 ~ 80	30 ~ 80	30 ~ 80
功率 Power (w)	1,840	1,840	2,200
電壓 Voltage (V)	220 ~ 240	220 ~ 240	220 ~ 240



座枱保溫櫃 Food Display Warmer

型號 Model	ED-2	ED-5	ED-7
尺寸 - 濶 × 深 × 高 Dimensions - W × D × H (mm)	400 × 325 × 465	575 × 325 × 465	400 × 325 × 615
溫度範圍 Temperature (°C)	30 ~ 85	30 ~ 85	30 ~ 85
功率 Power (w)	350	400	425
電壓 Voltage (V)	220	220	220



另有鋼門款



座枱保溫櫃 Warmer Cabinet

型號 Model	SW-017 (玻璃門 / 鋼門)	LPH037 太陽燈保暖櫃
尺寸 - 濶 × 深 × 高 Dimensions - W × D × H (mm)	425 × 460 × 925	510 × 305 × 410
溫度範圍 Temperature (°C)	20 ~ 110	
功率 Power (w)	1,500	100
電壓 Voltage (V)	220	220

港式蛋撻保溫箱 Egg Tart Warmer

型號 Model	ET1
底部尺寸 - 濶 × 深 × 高 Bottom Dimensions - W × D × H (mm)	585 × 600 × 80
功率 Power (w)	1,000
電壓 Voltage (V)	220



產品不斷改良，如有更改，均以實物為準。
Products are subject to change due to enhancements and continuous development.



DH-11-5F



■ 可用於酒店、餐廳、自助餐廳等場所
Suitable for Hotels, Restaurants, Cafeterias...etc.

■ 非常適用於外賣和外帶食物
For Restaurant delivery and food takeaways.



DH-11-21



DH-22-21

保溫餐車 Food Warmer Cart

型號 Model	DH-11-5F	DH-11-21	DH-22-21
外尺寸 - 闊 × 深 × 高 External Dimensions - W × D × H (mm)	790 × 975 × 1,350	790 × 975 × 1,795	1,540 × 940 × 1,795
內尺寸 - 闊 × 深 × 高 Chamber Dimensions - W × D × H (mm)	540 × 680 × 940	540 × 680 × 1,380	1,350 × 680 × 1,380
溫度範圍 Temperature (°C)	20 ~ 110	20 ~ 110	20 ~ 110
功率 Power (w)	2,620	2,620	2,620
電壓 Voltage (V)	220	220	220
其他 Others	可放 5 層 GN 2/1* (高度 160 mm) 5 × GN 2/1 (160 mm in between)	可放 11 層 GN 2/1* (每層高度 115 mm) 11 × GN 2/1 (115 mm in between)	可放 22 層 GN 2/1* (每層高度 115 mm) 22 × GN 2/1 (115 mm in between)

* 可另配層網。Optional Grid available.

另有 Roller Grill 保溫櫃，請參閱第 64 頁的「保溫櫃」。
Please see "Dish Warmer" on page 64.

 200CW+200
200JW+200

 200CW+302KS
200JW+323K

344-S



CCW



WI/2

醬汁分發器 / 保溫爐 Syrup Dispensers/Warmer

型號 Model	200CW+200	200JW+200	200CW+302KS	200JW+323K	244-S	344-S	444-S	CCW	WI/2
產品 Product	塑膠醬汁桶連蓋 Plastic Syrup Jar with Cover		塑膠醬汁桶連泵 Plastic Syrup Jar with Pump		不銹鋼醬汁分發器 Stainless Steel Syrup Dispensers			醬汁保溫分發器 Syrup Warming Dispenser	雙頭醬汁保溫爐 Sauce & Chocolate Warmer
品牌 (產地) Brand (Origin)	Cecilware (USA)	Cecilware (USA)	Cecilware (USA)	Cecilware (USA)	Cecilware (USA)	Cecilware (USA)	Cecilware (USA)	APW (USA)	Roller Grill (France)
尺寸 - 闊 × 深 × 高 Dimensions - W × D × H (mm)	187×116×200	187×116×270	187×116×280	187×116×360	254×222×191	368×222×191	483×222×191	216×362×387	310×210×230
容量 / 時產容量 Capacity/hr (l)	2.5	3.5	2.5	3.5	2×2.5	3×2.5	4×2.5	4	2×1
功率 Power (w)	-	-	-	-	-	-	-	396	340



DW-1A



PD-1A



FD-24HT

食物保溫燈 Food Warmer

型號 Model	DW-1A	PD-1A	FD-24HT	FD-36HT	FD-48HT	FD-60HT
產品 Product	座檯式 Desktop Food Warmer			掛式 Overhead Food Warmer		
品牌 (產地) Brand (Origin)	APW (USA)	APW (USA)	APW (USA)	APW (USA)	APW (USA)	APW (USA)
尺寸 - 闊 × 深 × 高 Dimensions - W × D × H (mm)	330×500×724	337×603×432	609×152×64	914×152×64	1,219×152×64	1,524×152×64
功率 Power (w)	500	575	575	920	1,265	1,610



型號 Model	L596-CPL	L598-CPL	L598-ALL	IFW-60-GL-10PN
產品 Product	枱架食物保溫燈 (銅色) Gantry Heat Shade	吊式食物保溫燈 (銅色) Copper Rise and Fall Heat Shade	吊式食物保溫燈 (鋁色) Aluminum Rise and Fall Heat Shade	碼檯式彈性臂紅外線暖食物燈 Flexible Arm Infra Red Warmer
品牌 (產地) Brand (Origin)	Lune (UK)	Lune (UK)	Lune (UK)	Crescor (USA)
尺寸 - 直徑 × 高 Dimensions - Dia. × H (mm)	Ø180×260	Ø180×400	Ø180×400	1,325
功率 Power (w)	250	250	250	250

產品不斷改良，如有更改，均以實物為準。
Products are subject to change due to enhancements and continuous development.



MAZE-4-SP



MAZE-44-SP



MAZE-46-SP



MAZE-66-SP

日本丸善電煮餃子機 Maruzen Electric Gyoza Cooker

型號 Model		尺寸 - 潤 × 深 × 高 + 背擋 Dimensions - W × D × H + back (mm)	烤盤尺寸 - 潤 × 深 Pan Dimensions - W × D (mm)				烤盤數量 No. of pans	消耗功率 Power consumption (w)	功率 Power
固定蓋 Fixed lid	可拆卸蓋 Removable lid		W	D	W	D			
MAZE-4-SP	MAZE-4S-SP	300 × 600 × (285 + 150)	220	330	-	-	1	3,000	
MAZE-6-SP	MAZE-6S-SP	410 × 600 × (285 + 150)	330	330	-	-	1	4,500	
MAZE-44-SP	MAZE-44S-SP	600 × 600 × (285 + 150)	220	330	220	330	2	6,000	
MAZE-46-SP	MAZE-46S-SP	710 × 600 × (285 + 150)	220	330	330	330	2	7,500	
MAZE-66-SP	MAZE-66S-SP	820 × 600 × (285 + 150)	330	330	330	330	2	9,000	



MREY-04

MREY-06

MREY-06D

MREY-03

MREK-045T

MREK-065T

日本丸善電煮麵機 Maruzen Electric Noodle Boiler

型號 Model	尺寸 - 潤 × 深 × 高 + 背擋 Dimensions - W × D × H + back (mm)	麵籃數量 No. of baskets	烹飪銅容量 Tank capacity(L)	消耗功率 Power consumption (w)	功率 Power
MREY-04-SP	450 × 450 × (800 + 150)	4	28	6,400	
MREY-06-SP	450 × 600 × (800 + 150)	6	40	9,000	
MREY-06D-SP	450 × 750 × (800 + 150)	6	40	9,000	3/ 380-415 / 50Hz
MREY-03-SP	255 × 600 × (800 + 150)	3	20	4,500	
MREK-045T-SP	450 × 530 × (300 + 150)	4	21	4,600	
MREK-065T-SP	600 × 560 × (300 + 150)	6	30	6,900	1/ 220-240V / 50Hz

* 另有煤氣型號以供選擇。 Gas auto gyoza cooker / noodle boiler is available



承接來圖訂造

TAILOR-MADE WELCOMED



不銹鋼煮食用具

Stainless Steel Cooking Equipment



H13



H14



H15



HC2



HC3



不銹鋼外賣車

STAINLESS STEEL TAKE-AWAY CART

聯品不銹鋼外賣車 Luen Pun Stainless Steel Take-away Cart

型號 Model	產品 Product	尺寸 - 闊 × 深 × 高 Dimensions - W × D × H		功率 Power (w)	附件 Accessories
		(mm)	(in)		
H13		1525 × 635 × (815 + 410)	60" × 25" × (32" + 16")	3000 + 3000	灼麵鑊 + 份數盤
H14	不銹鋼外賣車 Stainless Steel Take-away Cart	1525 × 635 × (815 + 410)	60" × 25" × (32" + 16")	3000 + 3000	份數盤
H15		1070 × 635 × (815 + 305)	42" × 25" × (32" + 12")	3000 + 3000	份數盤
HC2	不銹鋼外賣車 Stainless Steel Take-away Cart	815 × 510 × 815	32" × 20" × 32"	3000 + 3000	-
HC3		915 × 485 × 815	36" × 19" × 32"	3000 + 3000	湯桶



承接來圖訂造

TAILOR-MADE WELCOMED



不銹鋼外賣車
HC6



熱湯池車
HC5

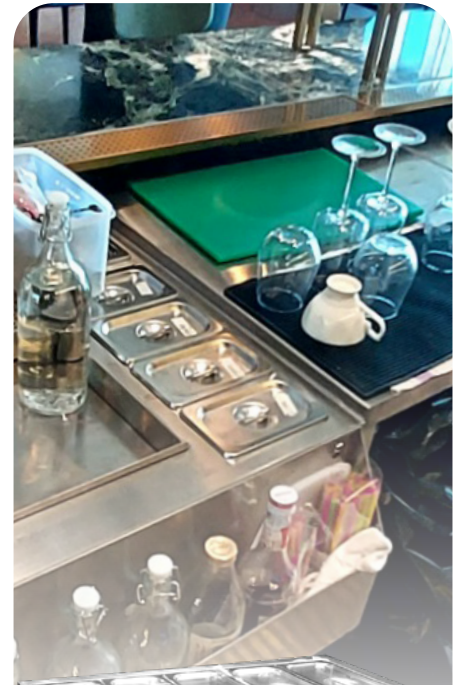

熱湯池車
HC4

不銹鋼外賣車
STAINLESS STEEL TAKE-AWAY CART

聯品不銹鋼外賣車 Luen Pun Stainless Steel Take-away Cart

型號 Model	產品 Product	尺寸 - 闊 × 深 × 高 Dimensions - W × D × H		功率 Power (w)	附件 Accessories
		(mm)	(in)		
HC6	不銹鋼外賣車 Stainless Steel Take-away Cart	1220 × 610 × 815	48" × 24" × 32"	3000 + 3000	-
HC4	熱湯池車 Stainless Steel Take-away Cart	970 × 395 × 815	38" × 15.5" × 32"	3500 + 3500	份數盤
HC5		610 × 715 × 815	24" × 28" × 32"	2500 + 2500	份數盤



承接來圖訂造

TAILOR-MADE WELCOMED

不銹鋼煮食用具

Stainless Steel Cooking Equipment



KM14.5
電暖粥罉



OW-1070
電熱湯罉



H009
麵罉連轆架



TM4
座枱勺麵罉



TM22
迷你勺麵車



TM5
日式勺麵罉



AM1/ AM2/ AM3
腸粉蒸櫃

聯品不銹鋼煮食用具 Luen Pun Stainless Steel Cooking Products

型號 Model	產品 Product	尺寸 - 直徑 × 高 Dimensions - Dia. × H		功率 Power (w)
		(mm)	(in)	
KM14.5	電暖粥罉 Porridge Boiler	Ø 375 × 715	Ø 14.5" × 28"	1,500 × 4
OW-1070	電熱湯罉 Soup Boiler	Ø 510 × 1070	Ø 20" × 42"	3,000 × 3
H009-M6KW12	麵罉連轆架 Noodle Boiler	Ø 305 × 775	Ø 12" × 30.5"	6,000
H009-M6KW14		Ø 360 × 775	Ø 14" × 30.5"	6,000
H009-M9KW16		Ø 410 × 775	Ø 16" × 30.5"	9,000
TM22	迷你勺麵車 Mini Noodle Boiler	360 × 560 × 790	14" × 22" × 31"	3,000 × 2
TM4	座枱勺麵罉 Noodle Boiler	445 × 445 × 395	17.5" × 17.5" × 15.5"	3,000 × 2
TM5	日式勺麵罉 Noodle Boiler	620 × 500 × 840	24" × 20" × 33"	3,000 × 3
AM1	腸粉蒸櫃 Steamed rice rolls making cabinet	622 × 483 × 787	24.5" × 19" × 31"	9,000
AM2		991 × 610 × 864	39" × 24" × 34"	9,000 × 2
AM3		686 × 432 × 787	27" × 17" × 31"	9,000

產品不斷改良，如有更改，均以實物為準。
Products are subject to change due to enhancements and continuous development.

不銹鋼煮食用具

STAINLESS STEEL COOKING EQUIPMENTS



代客申請 煤氣出牌工程



LP-1-GF(E) / LP-1-NF(E)



LP-2-GF(E) / LP-2-NF(E)

環保炒爐 – 廣東式 Environmental Cooking Range – Guangdong Style

型號 Model	尺寸 – 闊 × 深 × 高 Dimensions – W × D × H		熱負荷 Burner Rating (w)	尾鐸數量 No. of Rear pot
	(mm)	(in)		
LP-1-GF(E)	1200 × 1250 × (810 + 440)	47" × 49" × (32" + 17")	42,000	1
LP-1-NF(E)	1200 × 1050 × (810 + 440)	47" × 41" × (32" + 17")	42,000	1
LP-2-GF(E)	2200 × 1250 × (810 + 440)	87" × 49" × (32" + 17")	84,000 (42,000 × 2)	2
LP-2-NF(E)	2200 × 1050 × (810 + 440)	87" × 41" × (32" + 17")	84,000 (42,000 × 2)	2



LP-1A



LP-3C

環保蒸櫃 Environmental Steam Cabinet

型號 Model	尺寸 – 闊 × 深 × 高 Dimensions – W × D × H		熱負荷 Burner Rating (w)	尾鐸數量 No. of Rear pot
	(mm)	(in)		
LP-1A	800 × 880 × 1800	31.5" × 35" × 71"	42,000	8
LP-3C	900 × 880 × 1900	35.5" × 35" × 75"	42,000	4

矮湯爐 Stock Pot Stove

型號 Model		LP-1-14F(S)
尺寸 - 濶 × 深 × 高 Dimensions - W × D × H (mm)	(mm)	600 × 760 × (500 + 200)
	(in)	24" × 30" × (20" + 8")
燃氣接駁口尺寸 Gas Inlet Size	天然氣	ND25
	石油氣	ND25
	煤氣	ND25
熱負荷 Burner Rating	(w)	24,000



LP-1-14F(S)

燒豬爐 Pig Roaster

型號 Model		LP-3S
尺寸 - 濶 × 深 × 高 Dimensions - W × D × H (mm)	(mm)	620 × 1100 × 600
	(in)	24.5" × 43" × 24"
熱負荷 Burner Rating	(w)	50,000



LP-3S



LP-8S / LP-9S



LP-8E / LP-9E

烤鴨爐 Duck Roaster

型號 Model	外殼尺寸 - 直徑 × 高 Dimensions - Dia. × H		熱負荷 Burner Rating	烤鴨數量 No. of Duck
	(mm)	(in)		
LP-8S	∅ 810 × 1400	∅ 32" × 55"	16,000	6 ~ 7
LP-9S	∅ 910 × 1500	∅ 36" × 59"	16,000	8 ~ 9
LP-8E	∅ 870 × 1450	∅ 34" × 57"	16,000	6 ~ 7
LP-9E	∅ 1050 × 1550	∅ 41" × 61"	16,000	8 ~ 9



AS-44B (L/R)
單缸運輸帶式洗碗碟機



AS-44B (G) (L/R)
單缸運輸帶式洗碗碟機 (熱回收版)



AS-64B (L/R)
雙缸運輸帶式洗碗碟機



AS-64B (G) (L/R)
雙缸運輸帶式洗碗碟機 (熱回收版)

卓滙運輸帶式洗碗碟機 Champion - Conveyor Type Dishwasher

型號 Model	尺寸 - 濶 × 深 × 高 Dimensions - W × D × H (mm)	盛盤尺寸 - 濶 × 深 Rack - W × D (mm)	清洗缸容量 Tank Capacity (L)	每篩耗水量 / 籃 Rinse Usage/Rack (L)	時產量 / 籃 Rack/hr	功率 Power (w)	電壓 Voltage (V)
AS-44B (L/R)	1150 × 695 × 1640	500 × 500	65	2	230	53,000	380
*AS-44B (L/R)	1150 × 695 × 1640	500 × 500	65	2	230	23,000	380
AS-44B (G) (L/R)	1150 × 695 × 1979	500 × 500	65	2	230	44,000	380
*AS-44B (G) (L/R)	1150 × 695 × 1979	500 × 500	65	2	230	23,000	380
AS-64B (L/R)	1652 × 695 × 1913	500 × 500	166	2	268	70,000	380
*AS-64B (L/R)	1652 × 695 × 1913	500 × 500	166	2	268	70,000	380
AS-64B (G) (L/R)	1652 × 695 × 1979	500 × 500	166	2	268	60,500	380
*AS-64B (G) (L/R)	1652 × 695 × 1979	500 × 500	166	2	268	60,500	380

* 煤氣 Gas Heated * 左/右款 (L/R)

卓滙運輸帶式烘乾機 Champion - Conveyor Type Heat Dryer

型號 Model	AS-36	
尺寸 - 濶 × 深 × 高 Dimensions - W × D × H (mm)	(mm)	935.9 × 756 × 1960
出風口 Air Jets	(mm)	3 (500 x 20)
排氣口 Exhaust Vent	(mm)	400 x 100
熱風循環量 Air Circulation	(m ³ /hour)	2900
乾風溫度 Drying Temperature	(°C)	Avg. 75°C
功率 Power	(w)	11,000
電壓 Voltage	(V)	380



AS-36

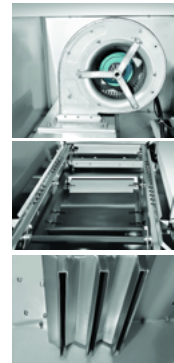

卓滙迷你長龍式洗碗碟機 (熱回收) Champion - Mini Flight Type Dishwasher (Heat Recovery)

型號 Model	AS-F(MG)	*AS-F(MG)
尺寸 - 濶 × 深 × 高 Dimensions - W × D × H (mm)	(mm)	2850 × 828 × 1934
清洗缸容量 Tank Capacity	(L)	83
運輸帶式速度: 篩 / 小時 Conveyor Type Speed	Rack / hr	230 Rack / hr
迷你長龍式速度: 篩 / 小時 Mini Flight Type Speed	Rack / hr	360 Rack / hr
電壓 Voltage	(V)	380
功率 Power	(w)	62,700



AS-F(MG)

* 煤氣 Gas Heated



AS-40
枱下式洗杯機



AS-50
枱下式洗碗碟機



卓滙檯下式洗杯機 / 洗碗碟機 Champion - Undercounter Type Glass-washer / Dishwasher

型號 Model	尺寸 - 闊 × 深 × 高 Dimensions - W × D × H (mm)	盛籃尺寸 - 闊 × 深 Rack - W × D (mm)	清洗缸容量 Tank Capacity (L)	每篩耗水量 / 籃 Rinse Usage/Rack (L)	時產量 / 籃 Rack/hr	功率 (w) Power (w)	電壓 Voltage (V)
AS-40	450 × 501 × 754	400 × 400	16	1.2	30	2,300	220
AS-50	600 × 601 × 775	500 × 500	25	2.5	40	3,700	220/380



開門高度
1900 mm



AS-3 (ADVANCE-T)
煤氣熱注揭門式洗碗碟機



AS-100 PLUS
節能型揭門式洗碗碟機



AS-100 HEAT PLUS
節能型揭門式洗碗碟機 (熱回收)

卓滙揭門式洗碗碟機 Champion - Door Type Dishwasher

型號 Model	尺寸 - 闊 × 深 × 高 Dimensions - W × D × H (mm)	盛籃尺寸 - 闊 × 深 Rack - W × D (mm)	清洗缸容量 Tank Capacity (L)	每篩耗水量 / 籃 Rinse Usage/Rack (L)	時產量 / 籃 Rack/hr	功率 (w) Power (w)	電壓 Voltage (V)
*AS-3 (Advance-T)	697 × 683 × 1621	500 × 500	24	2	40 - 60	2,800	220
AS-100 Plus	697 × 683 × 1625	500 × 500	24	1	40 - 60	9,000	380
*AS-100 Plus	697 × 683 × 1625	500 × 500	24	1	40 - 60	5,900	380
AS-100 (Heat Plus)	697 × 683 × 1802.2	500 × 500	24	1-1.5	60	9,000	380
*AS-100 (Heat Plus)	697 × 683 × 1802.2	500 × 500	24	1-1.5	60	5,900	380

* 煤氣 Gas Heated

日本星崎揭門式洗碗碟機 Hoshizaki - Door Type Dishwasher

型號 Model	HW-600A	
尺寸 - 闊 × 深 × 高 Dimensions - W × D × H (mm)	(mm)	615 × 718 × 1485
盛籃尺寸 - 闊 × 深 Rack - W × D	(mm)	500 × 500
清洗缸容量 Tank Capacity	(L)	22
每篩耗水量 / 籃 Rinse Usage/Rack	(L)	2
時產量 / 籃 Rack/hr	(hr)	48
功率 Power	(w)	3,000
電壓 Voltage	(V)	380



HW-600A



產品不斷改良，如有更改，均以實物為準。
Products are subject to change due to enhancements and continuous development.



■ 隱藏式提手
Hidden handle

■ 食品級不銹鋼層架
Food-grade stainless steel rack

■ 耐用不銹鋼外殼及內腔
Durable stainless steel body and inner

■ 智能微電腦溫控
Intelligent microcomputer temperature control

■ 櫃內溫度高達 125°C，有效殺菌
Sterilization temperature up to 125°C



單門消毒碗櫃
SK-23B



單門消毒碗櫃
SK-50



雙門光波型消毒碗櫃
SK-LW58



光波型消毒碗櫃
SK-LW60



第二代智能輕觸式消毒碗櫃
SK-DS50



雙門消毒碗櫃
SK-76



第二代智能輕觸式消毒碗櫃
SK-DS88



雙門光波消毒碗櫃
SK-DS108



雙門光波消毒碗櫃
SK-DS138



雙門光波消毒碗櫃
SK-DS288

日本山崎消毒碗櫃 SANKI - Dish Sterilizer

型號 Model	產品 Product	尺寸 - 潤 × 深 × 高 Dimensions - W × D × H (mm)	容量 Capacity (L)	功率 Power (w)	商品描述 Description
SK-23B	單門消毒碗櫃	430×320×300	23	300	- 遠紅外線高溫消毒 - Infrared red heat sterilization
SK-50	單門消毒碗櫃	430×345×515	44	500	
SK-LW58	雙門光波型消毒碗櫃	750×330×420	68	500	- 左室高溫光波消毒 (高達 125°C) - 右室低溫臭氧及遠紅外線殺菌 (低溫 70°C) - 鋼化玻璃面板 - The left cabinet use Halogen heat sterilization (up to 125°C) - The right cabinet use Ozone and infrared red sterilization (low-temperature 70°C) - Durable glass panel
SK-LW60	光波型消毒碗櫃	430×380×645	68	500	- 高溫光波消毒 (高達 125°C) - 鋼化鏡面玻璃面板 - 特設筷子架 - 容納大小餐具重量達 7 公斤 - Halogen heat sterilization (up to 125°C) - Durable mirror glass panel - Chopsticks rack is included - 7 kg Total Loading Capacity
SK-DS50	第二代智能輕觸式消毒碗櫃	438×330×520	44	500	- 遠紅外線高溫消毒 - 雙層鋼化玻璃面板 - 光波變頻高溫消毒 - 特設烘碗功能 - Infrared red heat sterilization - Double durable glass panel - Halogen heat-disinfection system - Heat-Drying Mode
SK-76	雙門消毒碗櫃	420×330×740	68	700	- 上層低溫臭氧及遠紅外線殺菌 (低溫 70°C) - 下層遠紅外線高溫消毒 (高達 125°C) - 鋼化玻璃面板 - The upper cabinet use Ozone and infrared red sterilization (low-temperature 70°C) - The lower cabinet use Infrared red heat sterilization (up to 125°C) - Durable glass panel
SK-DS88	第二代智能輕觸式消毒碗櫃	438×370×790	76	600	
SK-DS108	雙門光波消毒碗櫃	438×370×947	97	600	- 上層低溫臭氧及遠紅外線殺菌 (低溫 70°C) - 下層遠紅外線高溫消毒 (高達 125°C) - 智能實時溫度檢測 - 雙層鋼化玻璃面板 - The upper cabinet use Ozone and infrared red sterilization (low-temperature 70°C) - The lower cabinet use Infrared red heat sterilization (up to 125°C) - Smart real-time temperature detection - Double durable glass panel
SK-DS138	雙門光波消毒碗櫃	438×370×1122	117	800	
SK-DS288	雙門光波消毒碗櫃	480×400×1390	171	1100	

毛巾櫃 Towel Cabinet



MT25SE



MT150E

暖毛巾櫃 Towel Warmer

型號 Model	尺寸 Size (mm)	溫度 Temp. (°C)	存量 Storage (pcs)	功率 Power (w)	電壓 Voltage (V)
MT25SE	350×285×250	+75	25	130	220
MT50SE	420×285×290	+75	50	150	220
MT75SE	450×285×355	+75	75	180	220
MT150E	415×440×450	+75	150	320	220



HC-18S



HC-38

豪華暖毛巾櫃 Deluxe Towel Warmer

型號 Model	尺寸 Size (mm)	溫度 Temp. (°C)	存量 Storage (pcs)	功率 Power (w)	電壓 Voltage (V)
HC-18S	450×275×355	+70 ~ +80	96	200	220
HC-38	450×410×450	+70 ~ +80	200	400	220



冷凍毛巾櫃 Cool Cabi

型號 Model	尺寸 Size (mm)	溫度 Temp. (°C)	存量 Storage (pcs)	功率 Power (w)	電壓 Voltage (V)
CC-8	300×340×261	+7 ~ +10	35	85	220



單層冷暖毛巾櫃 Cold & Hot Towel Cabinet

型號 Model	尺寸 Size (mm)	溫度 Temp. (°C)	存量 Storage (pcs)	功率 Power (w)	電壓 Voltage (V)
MC75SA	450×320×330	+5 ~ +75	75	180	220



HC-38UV



HC-12UVe

紫外光殺菌暖毛巾櫃 Hot Cabi with UV Sterilizer

型號 Model	尺寸 Size (mm)	溫度 Temp. (°C)	存量 Storage (pcs)	功率 Power (w)	電壓 Voltage (V)
HC-38UV	455×320×290	+70 ~ +80	70	200	220
HC-12UVe	450×410×450	+30 ~ +90	198	410	220



不銹鋼暖毛巾車 Stainless Steel Towel Warmer

型號 Model	尺寸 Size (mm)	溫度 Temp. (°C)	功率 Power (w)	電壓 Voltage (V)
H006-H26	660×432×762	+70 ~ +80	3,000	220

滅蚊燈 Mosquito killer

型號 Model	尺寸 - 闊 × 深 × 高 Dimensions - W × D × H (mm)	功率 Power (w)
CM-883C-20W	385×88×320	20
CM-883C-30W	490×88×320	30



CM-883C-20W

CM-883C-30W



190°C



190°C



190°C



190°C

電炸爐 Electric Fryer

型號 Model	RFE8D	RFE12	RFE16C	RFE20C
尺寸 Size (mm)	400×600×445	400×600×445	400×600×980	400×600×980
功率 Power (w)	2×3,000 / 2×4,500	9,000	12,000	12,000
電壓 Voltage (V)	230 / 380	380	380	380



180°C



180°C



180°C

電炸爐 Electric Fryer

型號 Model	FD50	FD80	FD50+80
尺寸 Size (mm)	215×425×320	280×425×320	490×425×320
功率 Power (w)	3,200	3,400	3,200 + 3,400
電壓 Voltage (V)	230	230	2×230



180°C



180°C



180°C



180°C

電炸爐 Electric Fryer

型號 Model	FD80D	FD80R	FD120R	FD80DR
尺寸 Size (mm)	540×425×320	305×450×360	350×450×360	590×450×370
功率 Power (w)	2×3,400	3,400	6,400	2×3,400
電壓 Voltage (V)	2×230	230	380	2×230



1 GN 2/3
60°C



1 GN 1/1
60°C



1 GN 1/1
60°C



2 GN 1/1
60°C

電熱汁箱 Bain Maries

型號 Model	BM23	BMP11	BML11	BM21
尺寸 Size (mm)	360×355×280	320×580×260	535×370×260	695×650×260
功率 Power (w)	1,700	1,750	1,750	3,500
電壓 Voltage (V)	230	230	230	230



ROLLER GRILL

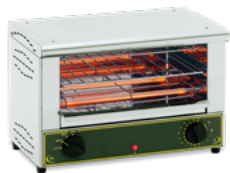

多士爐 Toaster

型號 Model	BAR1000
尺寸 Size (mm)	450×300×305
功率 Power (w)	2,000
電壓 Voltage (V)	230



多士爐 Toaster

型號 Model	BAR2000
尺寸 Size (mm)	450×300×420
功率 Power (w)	3,000
電壓 Voltage (V)	230



1 X GN 1/1

多士爐 Toaster

型號 Model	TS1270
尺寸 Size (mm)	640×380×335
功率 Power (w)	2,470
電壓 Voltage (V)	230



2 X GN 1/1

多士爐 Toaster

型號 Model	TS3270
尺寸 Size (mm)	640×380×475
功率 Power (w)	2×2,000
電壓 Voltage (V)	230 / 380



鏈式多士爐
Conveyor Oven

型號 Model	CT3000B
尺寸 Size (mm)	470×720×385
功率 Power (w)	3,000
電壓 Voltage (V)	230



多士爐輸送機 (雙出)
Toaster Conveyor (double exit)

型號 Model	CT540B
尺寸 Size (mm)	510×680×455
功率 Power (w)	2,650
電壓 Voltage (V)	230



20~95°C 1 X GN 1/1

保溫櫃 Warming Display

型號 Model	WD100
尺寸 Size (mm)	590×350×285
功率 Power (w)	650
電壓 Voltage (V)	230



20~95°C 2 X GN 1/1

保溫櫃 Warming Display

型號 Model	WD200
尺寸 Size (mm)	590×350×390
功率 Power (w)	650
電壓 Voltage (V)	230



20~95°C 1 X GN 1/1

保溫櫃 Warming Display

型號 Model	WDL 100
尺寸 Size (mm)	590×350×375
功率 Power (w)	650
電壓 Voltage (V)	230



20~95°C 2 X GN 1/1

保溫櫃 Warming Display

型號 Model	WDL 200
尺寸 Size (mm)	590×350×480
功率 Power (w)	650
電壓 Voltage (V)	230



保溫櫃 Warming Display

型號 Model	WD 780 S	WD 780 D
尺寸 Size (mm)	780×490×480	780×490×640
功率 Power (w)	1,200	1,800
電壓 Voltage (V)	230	230



20~90°C



3 GN 1/1
90°C

保溫櫃 Bain Maries Display

型號 Model	BMV3
尺寸 Size (mm)	1025×645×700
功率 Power (w)	3,500
電壓 Voltage (V)	230



4 GN 1/1
90°C

保溫櫃 Bain Maries Display

型號 Model	BMV4
尺寸 Size (mm)	1400×645×700
功率 Power (w)	3,600
電壓 Voltage (V)	230



3 GN 1/1
+20°C/+95°C

保溫櫃 Showcase

型號 Model	VHC1000
尺寸 Size (mm)	1000×720×475
功率 Power (w)	2,400
電壓 Voltage (V)	230



GN 1/3

煮蛋器 Egg Cooker

型號 Model	CO 60
尺寸 Size (mm)	215×430×255
功率 Power (w)	1,200
電壓 Voltage (V)	230



暖醬機 Sauce warmer

型號 Model	WI/1
尺寸 Size (mm)	225×175×255
功率 Power (w)	170
電壓 Voltage (V)	230



暖醬機 Double Sauce warmer

型號 Model	WI/2
尺寸 Size (mm)	310×210×255
功率 Power (w)	340
電壓 Voltage (V)	230



熱狗機 Hot-dog Machine

型號 Model	CS 2 E
尺寸 Size (mm)	260×380×400
功率 Power (w)	500
電壓 Voltage (V)	230



熱狗機 Hot-dog Machine

型號 Model	CS 3 E
尺寸 Size (mm)	440×300×400
功率 Power (w)	650
電壓 Voltage (V)	230



火山石烤箱 Electric grill with lava rocks

型號 Model	140
尺寸 Size (mm)	300×545×160
功率 Power (w)	2,500
電壓 Voltage (V)	230

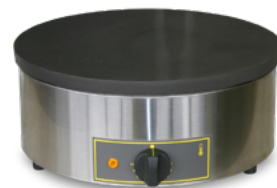

20~300°C

班戟爐 Crepe Machine

型號 Model	CFE 400
尺寸 Size (mm)	400×190
功率 Power (w)	3,600
電壓 Voltage (V)	230



300°C

班戟爐 Crepe Machine

型號 Model	CVE 400
尺寸 Size (mm)	450×480×210
鐵板 Plate (mm)	Ø400
功率 Power (w)	2,500
電壓 Voltage (V)	230



300°C

班戟爐 Electric crepe maker - 1 plate

型號 Model	CSE 350	CSE 400
尺寸 Size (mm)	450×480×240	450×480×240
鐵板 Plate (mm)	Ø350	Ø400
功率 Power (w)	3,000	3,600
電壓 Voltage (V)	230	230



300°C

班戟爐 Double and electric crepe maker - 2 plates

型號 Model	CDE 350	CDE 400
尺寸 Size (mm)	860×480×240	860×480×240
鐵板 Plate (mm)	Ø350	Ø400
功率 Power (w)	3,000×2	3,600×2
電壓 Voltage (V)	230 / 380	230 / 380



GES10 300°C



GES20 300°C



GES23 300°C



GES40 300°C



GES75 300°C



GES80 300°C

窩夫爐 Waffle Iron

型號 Model	GES10	GES20	GES23	GES40	GES75	GES80
尺寸 Size (mm)	305×440×230	305×440×230	305×440×230	305×440×230	305×440×230	305×440×230
窩夫尺寸 Waffle (mm)	100×170×22	100×180×26	230×60×30	250×250×4	Ø 185 mm, H: 26 mm	155×40×40
功率 Power (w)	1,600	1,600	1,600	1,600	1,600	1,600
電壓 Voltage (V)	230	230	230	230	230	230

窩夫爐 (雙頭) Double Waffle Iron

型號 Model	GED10	GED20	GED40	GED75	GED80
尺寸 Size (mm)	550×440×230	550×440×230	550×440×230	550×440×230	550×440×230
窩夫尺寸 Waffle (mm)	100×170×22	100×180×26	250×250×4	Ø 185 mm, H: 26 mm	155×40×40
功率 Power (w)	3,200	3,200	3,200	3,200	3,200
電壓 Voltage (V)	230	230	230	230	230



ROLLER GRILL

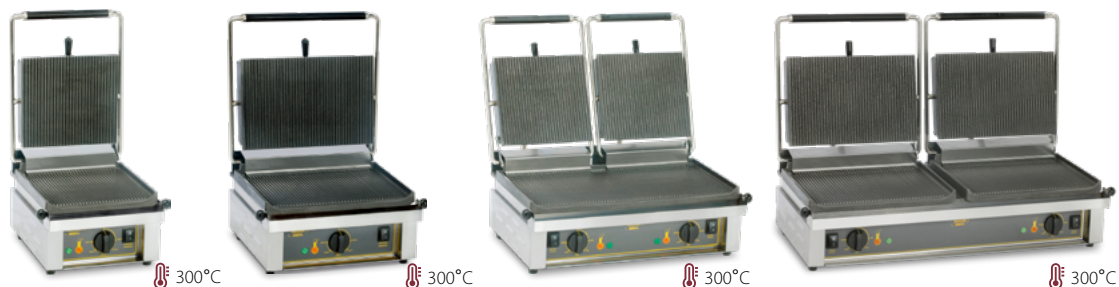

接觸式坑紋烤爐 Cast-iron contact grill

型號 Model	SAVOYE	PANINI	MAJESTIC (雙頭 double)	DOUBLE PANINI (雙頭 double)
尺寸 Size (mm)	280×460×280	430×385×220	560×460×280	760×460×280
煮食面板 Cooking surface (mm)	260×240	360×240	535×240	2×(360×240)
功率 Power (w)	2,000	3,000	2×2,000	2×3,000
電壓 Voltage (V)	230	230	230/380	230/380



接觸式坑紋烤爐 Extra-large cast-iron contact-grill

電扒爐 (鑄鐵板) Electric griddle with cast-iron plate

型號 Model	PANINI XLB / PANINI XLE B	PSF 400 E	PSF 600 E
尺寸 Size (mm)	380×600×320	400×475×230	600×475×230
煮食面板 Cooking surface (mm)	360×360	400×400	600×400
功率 Power (w)	3,600	3,000	2×3,000
電壓 Voltage (V)	230	230	230 / 380



電扒爐 (鋼板) Electric griddle with decarbonised steel / enamelled steel plate

型號 Model	PSR 400 E / PSR 400 EE	PSR 600 E / PSR 600 EE	PSR 900 E / PSR 900 EE
尺寸 Size (mm)	400×475×230	600×475×230	900×475×230
煮食面板 Cooking surface (mm)	400×400	600×400	900×400
功率 Power (w)	3,000	2×3,000	3×3,000
電壓 Voltage (V)	230	230 / 380	230 / 380



電扒爐 Enamelled and gas plancha grill

電三文魚煙燻爐 Electric Salmon Smoker

型號 Model	PL 400 G	型號 Model	PSF 400 E	PSF 600 E
尺寸 Size (mm)	400×430×280	尺寸 Size (mm)	1000×410×200	715×415×360
煮食面板 Cooking surface (mm)	390×380	烹飪格網 Cooking grid (mm)	800×400	下層 Lower grid: 600×400 上層 Upper grid: 545×340
功率 Power (w)	2,750	功率 Power (w)	250	250
電壓 Voltage (V)	230	附件 Accessories	附自動點火裝置、電熱絲和計時器 Complete with automatic ignition, heating element and time	

產品不斷改良，如有更改，均以實物為準。
Products are subject to change due to enhancements and continuous development.

ROLLER GRILL 餐飲設備
Roller Grill Catering Equipment

法國 ROLLER GRILL 產品大全 ROLLER GRILL PRODUCTS



600×400 mm 300°C

多功能焗爐 Multifunctions Oven

型號 Model	FC110EG
尺寸 Size (mm)	795×755×595
功率 Power (w)	6,000
電壓 Voltage (V)	380



4 GN 2/3 300°C

多功能焗爐 Multifunctions Oven

型號 Model	FC60/ FC60TQ
尺寸 Size (mm)	595×610×590
功率 Power (w)	3,000
電壓 Voltage (V)	230



270°C

多功能焗爐 Multifunctions Oven

型號 Model	FC380TQ
尺寸 Size (mm)	550×550×355
功率 Power (w)	2,600
電壓 Voltage (V)	230



270°C

多功能焗爐 Multifunctions Oven

型號 Model	FC280
尺寸 Size (mm)	460×550×355
功率 Power (w)	1,500
電壓 Voltage (V)	230



GN 1/2 270°C

直立式焗爐 Vertical Oven

型號 Model	FCV280
尺寸 Size (mm)	370×535×495
功率 Power (w)	1,500
電壓 Voltage (V)	230



2×Ø32 cm
640×400 mm 350°C

座枱式 Pizza 爐 Pizza Oven

型號 Model	PZ4302D
尺寸 Size (mm)	895×580×270
功率 Power (w)	3+2,000
電壓 Voltage (V)	230

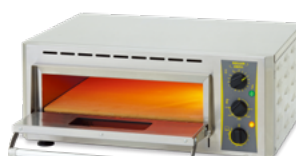

1×Ø41 cm 350°C

座枱式 Pizza 爐 Pizza Oven

型號 Model	PZ430S
尺寸 Size (mm)	670×580×270
功率 Power (w)	3,000
電壓 Voltage (V)	230



2×Ø41 cm 350°C

座枱式 Pizza 爐 Pizza Oven

型號 Model	PZ430D
尺寸 Size (mm)	670×580×500
功率 Power (w)	3,000/6,000
電壓 Voltage (V)	230/380



600×600 mm 30°C

電發酵櫃 Proofer

型號 Model	EP800
尺寸 Size (mm)	795×640×910
功率 Power (w)	1,400
電壓 Voltage (V)	230



保溫櫃 Dish Warmer

DW106	DW110
400×215×335	400×215×475
650	1,300
230	230



3 GN 2/3

通風保溫櫃 Ventilated foodwarmer

HVC60GN
425×460×925
1,500
230



3 GN 1/1

HVC120GN
800×460×925
3,000
230



2x GN 1/1

展示雪櫃 Display Cabinet

+2~+10°C

型號 Model	CD 800
尺寸 Size (mm)	785×650×735
功率 Power (w)	390
電壓 Voltage (V)	230



3x GN 1/1

展示雪櫃 Display Cabinet

+2~+10°C

型號 Model	CD 1200
尺寸 Size (mm)	1185×650×735
功率 Power (w)	490
電壓 Voltage (V)	230



升降面火爐 Salamander

型號 Model	SEM600B / SEM600Q
尺寸 Size (mm)	600×640×590
功率 Power (w)	3,000
電壓 Voltage (V)	230



升降面火爐 Salamander

型號 Model	SEM600PDS	SEM800PDS
尺寸 Size (mm)	600×640×590	800×640×590
功率 Power (w)	3,000 / 5,000	4,500
電壓 Voltage (V)	230 / 380	380



升降面火爐 Salamander

型號 Model	SEM800B / SEM800Q
尺寸 Size (mm)	800×640×590
功率 Power (w)	4,500
電壓 Voltage (V)	380



升降面火爐 Salamander

型號 Model	SEF800B / SEF800Q
尺寸 Size (mm)	800×640×590
功率 Power (w)	4,500
電壓 Voltage (V)	380



烤肉機 Rotisserie

型號 Model	RBE80Q
尺寸 Size (mm)	940×450×845
功率 Power (w)	4,400
電壓 Voltage (V)	380



烤肉機 Rotisserie

型號 Model	RBE120Q
尺寸 Size (mm)	940×450×845
功率 Power (w)	6,600
電壓 Voltage (V)	380



烤肉機 Rotisserie

型號 Model	RBE200Q
尺寸 Size (mm)	940×450×1250
功率 Power (w)	14,000
電壓 Voltage (V)	380



烤肉機 Gyros Grill

型號 Model	GR40E
尺寸 Size (mm)	580×660×690
功率 Power (w)	3,600
電壓 Voltage (V)	230



烤肉機 Gyros Grill

型號 Model	GR60E
尺寸 Size (mm)	580×660×860
功率 Power (w)	5,800
電壓 Voltage (V)	380



烤肉機 Panoramic Rotisserie

型號 Model	RBE25	RE2
尺寸 Size (mm)	850×700×850	850×700×1050
功率 Power (w)	8,500	1,500
電壓 Voltage (V)	380	230

GN 1/1 (RE 2)
90°C (RE 2)

適用於風量需求大的地方 如工地、廚房、飯堂、貨倉、禮堂等。

- 風速強勁
Strong wind speed
- 耐用可靠
Durable and reliable
- 寧靜
Quiet
- 可調節風速
Adjustable fan speed

地台風扇 Floor Fan

型號 Model	產品 Product	尺寸-Ø 直徑 Dimensions - W × D × H (mm)	功率 Power (w)
FE-300	12 吋地台扇	Ø300	80
FE-350	14 吋地台扇	Ø350	100
FE-400	16 吋地台扇	Ø400	120
FE-450	18 吋地台扇	Ø450	160
FE-500	20 吋地台扇	Ø500	200



商用風扇
FANS



工業空調冷風機 Air Cooler Fan

型號 Model	適用範圍 Application scope (m ²)	水箱容量 Water tank (L)	尺寸-闊 × 深 × 高 Dimensions - W × D × H (mm)	功率 Power (w)	風速檔位 Speed	其他 Other
39J	5 ~ 15	35	455 × 335 × 825	80		
40J	20 ~ 30	55	490 × 350 × 1050	150	3 檔風速 + 冷風檔 3 speeds + cold wind speed	兩面水簾; 冰晶 × 4; 揭蓋加水 Two Sides Water Pads; Ice crystal × 4 Uncover and add water
251JS	40 ~ 50	60	600 × 400 × 1150	200		
26JS	50 ~ 70	70	720 × 460 × 1220	420	3 檔風速 + 冷風檔 3 speeds + cold wind speed	兩面水簾; 冰晶 × 4; 揭蓋加水; 自動加水 Two Sides Water Pads; Ice crystal × 4 Uncover and add water; Automatically replenishing water
35J	60 ~ 100	90	830 × 550 × 1400	750	4 檔風速 + 冷風檔 4 speeds + cold wind speed	兩面水簾; 冰晶 × 4; 揭蓋加水; 自動加水 Two Sides Water Pads; Ice crystal × 4 Uncover and add water; Automatically replenishing water



度身訂造商用廚房設備

TAILOR-MADE WELCOMED



• 電扒爐 / 勺麵鑊 / 中式焗爐



• 勺麵鑊 / 不銹鋼架 / 電飯煲



• 勺麵鑊 / 不銹鋼雪櫃 / 四頭電磁爐 / 油煙罩



• 多用途蒸焗爐 / 電熱三門壓力蒸櫃 / 不銹鋼工作枱 / 不銹鋼吊架 / 不銹鋼星盤 / 廣東式環保炒爐



• 不銹鋼工作枱 / 不銹鋼吊架 / 不銹鋼星盤 / 上牆層板 / 廣東式環保炒爐 / 油煙罩



• 不銹鋼工作枱 / 不銹鋼星盤 / 電扒爐 / 電炸爐 / 勺麵鑊

設備安裝實例
EQUIPMENT INSTALLATION REFERENCES

聯品企業集團有限公司

(852) 2718 1817

info@luenpun.com.hk

www.luenpun.com.hk

